

2025-2026 FIRST® Tech Challenge

Competition Manual

DECODE™ Presented by RTX



DECODE™

PRESENTED BY  RTX

FIRST®
TECH
CHALLENGE

Contents

1	Introduction	7
1.1	About FIRST®	7
1.2	FIRST® Tech Challenge	7
1.3	FIRST Ethos and Core Values	8
1.3.1	Core Values	8
1.3.2	Gracious Professionalism®, a FIRST Credo	8
1.3.3	Coopertition®	9
1.4	Spirit of Volunteering	9
1.5	Accessibility and Inclusion	10
1.6	This Document & Its Conventions	10
1.7	Translations & Other Versions	12
1.8	Team Updates	12
1.9	Question and Answer System	12
2	FIRST Season Overview	15
3	Competition Eligibility and Inspection (I)	17
3.1	Team Eligibility Rules	17
3.2	Awards Eligibility Rules	18
3.3	MATCH Eligibility Rules	18
4	Advancement	23
4.1	Advancement Points Calculation	24
4.1.1	Qualification Phase Performance	26
4.1.2	ALLIANCE Selection Results	27
4.1.3	Playoff Performance	27
4.1.4	Team Judged Awards	27
4.2	Advancement Distribution by Region	28
5	Event Rules (E)	29
5.1	General Rules	29
5.2	Machine Shops and Host Team Build Spaces	33
5.3	Wireless Rules	33
5.4	Load-In	33
5.5	Pits	34
5.6	ROBOT Carts	36
5.7	Ceremonies	36
5.8	In the Stands	37
6	Awards (A)	39
6.1	Team Judged Awards Overview and Schedule	39
6.1.1	Sources of Information Considered for Awards	40

6.1.2	Structured Interview.....	42
6.1.3	Pit Interview(s)	42
6.1.4	Sustained Outreach and Demonstrating Impact by Numbers.....	44
6.2	Team Judged Award Rules	44
6.3	Team Judged Award Descriptions	48
6.3.1	Inspire Award.....	48
6.3.2	Think Award.....	50
6.3.3	Connect Award.....	50
6.3.4	Reach Award	51
6.3.5	Sustain Award	51
6.3.6	Innovate Award sponsored by RTX.....	52
6.3.7	Control Award.....	52
6.3.8	Design Award	53
6.3.9	Judges' Choice Award	53
6.4	Tournament ALLIANCE Awards	54
6.4.1	Winning Alliance Award.....	54
6.4.2	Finalist Alliance Award	54
6.5	Individual Awards	54
6.5.1	FIRST Leadership Award	54
6.5.2	Compass Award.....	54
6.6	Project-Based Global Awards	55
6.6.1	Digital Animation Award sponsored by Worcester Polytechnic Institute (WPI).....	55
6.6.2	Safety Animation Award sponsored by UL Solutions.....	55
7	Game Sponsor Recognition.....	57
8	Game Overview.....	58
9	ARENA.....	59
9.1	Dimensions and Accuracy	59
9.2	FIELD.....	60
9.3	Areas, Zones, & Markings.....	61
9.4	TILE Coordinates	63
9.5	ALLIANCE AREA.....	64
9.6	OBELISK.....	65
9.7	GOAL.....	66
9.8	CLASSIFIER	68
9.8.1	SQUARE	69
9.8.2	RAMP	69
9.8.3	GATE	72
9.9	SCORING ELEMENTS	73
9.10	AprilTags	74
9.11	FIELD STAFF	76
9.12	Event Management System	77

10	Game Details.....	79
10.1	MATCH Overview.....	79
10.2	DRIVE TEAM.....	79
10.3	Setup.....	80
10.3.1	SCORING ELEMENTS.....	81
10.3.2	DRIVE TEAMS.....	82
10.3.3	OPERATOR CONSOLES	82
10.3.4	ROBOTS	82
10.4	MATCH Periods	83
10.5	Scoring.....	83
10.5.1	ARTIFACT Scoring Criteria	84
10.5.2	PATTERN Scoring Criteria	86
10.5.3	ROBOT Scoring Criteria.....	87
10.5.4	Point Values.....	88
10.6	Violations.....	89
10.6.1	YELLOW and RED CARDS.....	89
10.6.2	YELLOW and RED CARD application.....	90
10.6.3	YELLOW and RED CARDS during Playoff MATCHES.....	91
10.6.4	Violation Details	91
10.7	Head REFEREE	93
10.8	Other Logistics.....	93
11	Game Rules (G).....	95
11.1	Personal Safety.....	95
11.2	Conduct.....	95
11.3	Pre-MATCH	99
11.4	In-MATCH.....	103
11.4.1	AUTO.....	103
11.4.2	TELEOP	105
11.4.3	SCORING ELEMENT	105
11.4.4	ROBOT.....	107
11.4.5	Opponent Interaction	110
11.4.6	Human	114
12	ROBOT Construction Rules (R).....	119
12.1	General ROBOT Design.....	121
12.2	ROBOT Safety & Damage Prevention.....	125
12.3	Fabrication	127
12.4	ROBOT SIGN Rules	130
12.5	Motors & Actuators	133
12.6	Power Distribution	136
12.7	Control, Command & Signals System	143
12.8	Pneumatic Systems.....	148

12.9	OPERATOR CONSOLE	150
13	Tournament (T).....	153
13.1	Overview	153
13.2	General Tournament Rules	153
13.3	MATCH Replays.....	157
13.4	Clarifications on MATCH Play Results (“Question Box”).....	158
13.5	Practice MATCHES.....	159
13.5.1	Filler Line.....	160
13.6	Qualification MATCHES	160
13.6.1	Schedule	160
13.6.2	MATCH Assignment	161
13.6.3	Qualification Ranking.....	161
13.7	Playoff MATCHES.....	163
13.7.1	ALLIANCE Selection Process	164
13.7.2	Playoff MATCH Bracket.....	164
13.7.3	2-ALLIANCE Bracket and Typical Timing	166
13.7.4	4-ALLIANCE Bracket and Typical Timing	167
13.7.5	6-ALLIANCE Bracket and Typical Timing	168
13.7.6	8-ALLIANCE Bracket and Typical Timing	169
13.8	Dual Division Events	170
13.8.1	Dual Division Advancement Points.....	171
13.8.2	Dual Division Playoffs.....	172
14	League Play Tournaments (L)	175
15	FIRST Championship (C).....	177
15.1	Awards Modifications	177
15.1.1	Championship Portfolio Submissions.....	177
15.1.2	Championship Interview Process	177
15.1.3	Championship Compass Award Submissions.....	178
15.2	Game Modification	178
15.2.1	FIELDS.....	178
15.2.2	Scoring and Timing.....	179
15.3	3-ROBOT ALLIANCES	179
15.4	FIRST Championship Pit Crews	179
15.5	FIRST Championship Playoffs	180
15.5.1	da Vinci Tournament MATCH Bracket	180
15.5.2	da Vinci Round-Robin Tournament Ranking	181
15.5.3	FIRST Championship da Vinci Finals	181
16	Glossary	183

1 Introduction

1.1 About *FIRST*®

FIRST® (For Inspiration and Recognition of Science and Technology) was founded by inventor Dean Kamen to inspire young people's interest in science and technology. As a robotics community that prepares young people for the future, *FIRST* is the world's leading youth-serving nonprofit advancing STEM education. For 30 years, *FIRST* has combined the rigor of STEM learning with the fun and excitement of traditional sports and the inspiration that comes from community through programs that have a proven impact on learning, interest, and skill-building inside and outside of the classroom. *FIRST* provides programs that span a variety of age groups:

- *FIRST*® Robotics Competition for grades 9-12, suggested ages 14-18
- *FIRST*® Tech Challenge for grades 7-12, suggested ages 12-18
- *FIRST*® LEGO® League for grades Pre-K-8, ages 4-16
 - *FIRST*® LEGO® League Challenge for grades 4-8 (ages 9-16, ages vary by country)
 - *FIRST*® LEGO® League Explore for grades 2-4 (ages 6-10)
 - *FIRST*® LEGO® League Discover for grades Pre-K-1 (ages 4-6)

Please visit [the *FIRST* website](http://theFIRSTwebsite) for more information about *FIRST* and its programs.

Purpose

FIRST exists to prepare the young people of today for the world of tomorrow.

Vision

To transform our culture by creating a world where science and technology are celebrated and where young people dream of becoming science and technology leaders.

Mission

The mission of *FIRST* is to provide life-changing robotics programs that give young people the skills, confidence, and resilience to build a better world.

1.2 *FIRST*® Tech Challenge

FIRST Tech Challenge is a student-centered program that focuses on giving young people a unique and stimulating experience. Every September, at an event known as "Kickoff", a new game challenge is introduced. Once the challenge is released, small teams of students with the help of mentors design, build, test, and program robots that must perform a series of game tasks autonomously and under driver control. These teams then put their skills to the test in a series of tournaments which combine the excitement of a competitive sport while encouraging students to help and learn from one another.

Participants and alumni of *FIRST* programs gain access to education and career discovery opportunities, connections to exclusive scholarships and employers, and a place in the *FIRST* community for life. To learn more about *FIRST*® Tech Challenge and other *FIRST*® Programs, visit www.firstinspires.org.

1.3 **FIRST** Ethos and Core Values

1.3.1 Core Values

The *FIRST* Core Values are fundamental to *FIRST* and unique to its programs. They emphasize friendly sportsmanship, respect for the contributions of others, teamwork, learning, and community involvement and are part of our commitment to fostering, cultivating, and preserving a culture of unity.

Our community expresses the *FIRST* philosophies of Gracious Professionalism® and Coopertition® through the *FIRST* Core Values.

Discovery: We explore new skills and ideas.

Innovation: We use creativity and persistence to solve problems.

Impact: We apply what we learn to improve our world.

Inclusion: We respect each other and embrace our differences.

Teamwork: We are stronger when we work together.

Fun: We enjoy and celebrate what we do!

1.3.2 Gracious Professionalism®, a *FIRST* Credo

Gracious Professionalism® is part of the ethos of *FIRST*. It's a way of doing things that encourages high quality work, emphasizes the value of others, and respects individuals and the community. *Gracious Professionalism* is not clearly defined for a reason. It is an aspirational ideal to always strive towards, not a goal to be achieved or a method of measuring someone, and for this reason, you can never say someone "is" or "is not" being Graciously Professional. We should each work to better embody Gracious Professionalism in all our actions. How we pursue this can and should mean different things to everyone.

Some possible meanings of *Gracious Professionalism* include:

- gracious attitudes and behaviors are win-win,
- gracious folks respect others and let that respect show in their actions,
- professionals possess special knowledge and are trusted by society to use that knowledge responsibly, and
- gracious professionals make a valued contribution in a manner pleasing to others and to themselves.

In the context of *FIRST*, this means that all teams and participants should:

- learn to be strong competitors, but also treat one another with respect and kindness in the process and
- avoid leaving anyone feeling as if they are excluded or unappreciated.

Knowledge, pride, and empathy should be comfortably and genuinely blended.

In the end, *Gracious Professionalism* is part of pursuing a meaningful life. When professionals use knowledge in a gracious manner and individuals act with integrity and sensitivity, everyone wins and society benefits.

Figure 1-1: Dr. Woodie Flowers, Gracious Professionalism advocate and exemplar



“The FIRST spirit encourages doing high-quality, well-informed work in a manner that leaves everyone feeling valued. Gracious Professionalism seems to be a good descriptor for part of the ethos of FIRST. It is part of what makes FIRST different and wonderful.”

*- Dr. Woodie Flowers, (1943 – 2019)
Distinguished Advisor to FIRST*

It is a good idea to spend time going over this concept with your team and reinforcing it regularly. We recommend providing your team with real-life examples of *Gracious Professionalism* in practice, such as when a team loans valuable materials or expertise to another team that they will later face as an opponent in competition. Routinely highlight opportunities to display *Gracious Professionalism* at events and encourage team members to suggest ways in which they can demonstrate this quality themselves and through outreach activities.

1.3.3 Coopertition®

At FIRST, *Coopertition*® is displaying unqualified kindness and respect in the face of fierce competition. *Coopertition* is founded on the concept and philosophy that teams can and should help and cooperate with one another even as they compete. *Coopertition* involves learning from teammates and mentors. *Coopertition* means competing always but assisting and enabling others when you can.

1.4 Spirit of Volunteering

FIRST can only hope to achieve our mission of providing life-changing robotics programs that give young people the skills, confidence, and resilience to build a better world with your help.

There are two phrases which drive and motivate the individuals that volunteer their time for FIRST: “Giving Back” and “Pay It Forward.” Each year, you have the extraordinary opportunity to help create the best-ever experience for our fellow volunteers, mentors, and students by becoming a FIRST volunteer.

To our team members and mentors: remember that the volunteers you interact with are dedicating their most precious asset - their time - to ensure that all teams have a fulfilling, fun, and memorable competition. Volunteers are the lifeblood of FIRST, and without them, FIRST would not be where it is today. We urge you to remember that *Gracious Professionalism* is part of the ethos of FIRST. It's a way of doing things that encourages high-quality work, emphasizes the value of others, and respects individuals and the community.

We strive to train each volunteer to always exhibit Gracious Professionalism - we hope we can work together to create an environment where all feel safe and welcome.

Please consider [volunteering at local events](#) near you but know that not all applicants can be placed in all roles at any given event. Please work with your volunteer coordinator and local Program Delivery Partner (PDP) to help identify the most meaningful way you can help in your region. A complete set of all role-specific volunteer materials can be found on our [Volunteer Resources Page](#).

1.5 Accessibility and Inclusion

FIRST is committed to *STEM for Everyone™* and as such, FIRST makes reasonable accommodations for persons with disabilities who need and request accommodations. If a participant needs accommodation for an event, please [contact your local leadership](#) before the event so they can help ensure the accommodation is provided. Local leadership may make exceptions to rules to allow for reasonable accommodation given the exceptions do not create an undue hardship or cause safety concerns.

1.6 This Document & Its Conventions

The 2025-2026 Competition Manual is a resource for all FIRST Tech Challenge teams for information specific to the 2025-2026 season and the DECODE™ presented by RTX game. Its audience will find the following details:

- a general overview of the DECODE game,
- detail about the DECODE playing FIELD,
- a description of how to play the DECODE game,
- rules (related to safety, conduct, gameplay, inspection, event, etc.),
- ROBOT construction rules, and
- a description of how teams advance at 2025-2026 tournaments and throughout the season.

The intent of this manual is that the text means exactly, and only, what it says. Please avoid interpreting the text based on assumptions about intent, implementation of past rules, or how a situation might be in “real life.” There are no hidden requirements or restrictions. If you’ve read the entire manual, you already know everything needed for your journey.

Specific methods are used throughout this manual to highlight warnings, cautions, key words, and phrases. These conventions are used to alert the reader to important information and are intended to help teams in constructing a ROBOT that complies with the rules in a safe manner.

Links to other section headings and rule references within this manual appear in [blue underlined text with a grey background](#). Links to external resources appear [blue underlined text](#).

For linked references not included in a preview release of this document, the links will appear with the section letter and ### for the rules number within square brackets. For example, a cross link to a game rule before a game rule is released will appear as [\[G###\]](#) and will be replaced with the current linked rule when that section of the manual is released.

Key words that have a particular meaning within the context of FIRST Tech Challenge and DECODE are defined in section [16 Glossary](#) and indicated in ALL CAPS throughout this document.

The rule numbering method indicates the section, subsection, and position of the rule within that subsection. The letter indicates the section in which the rule is published.

- I for Section [3 Competition Eligibility and Inspection \(I\)](#)
- E for Section [5 Event Rules \(E\)](#)
- A for Section [6 Awards \(A\)](#)
- G for Section [11 Game Rules \(G\)](#)
- R for Section [12 ROBOT Construction Rules \(R\)](#)
- T for Section [13 Tournament \(T\)](#)
- L for Section [14 League Play Tournaments \(L\)](#)
- C for Section [15 FIRST Championship \(C\)](#)

The following digit(s) represents the subsection in which the rule can be found. The final digits indicate the rule’s position within that subsection.

Figure 1-2 Rule numbering method

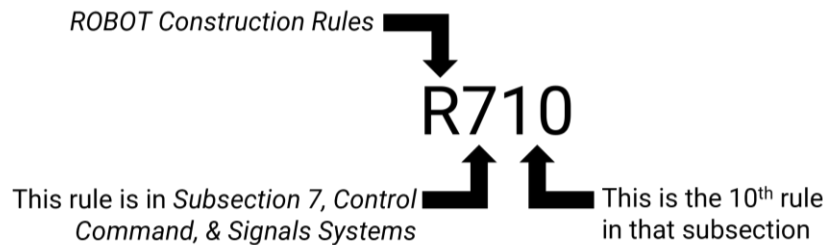

Warnings, cautions, and notes appear in orange boxes. Pay close attention to their contents as they’re intended to provide insight into the reasoning behind a rule, helpful information on understanding or interpreting a rule, and/or possible “best practices” for use when implementing systems affected by a rule.

While orange boxes are part of the manual, they do not carry the weight of the actual rule (if there is an inadvertent conflict between a rule and its orange box, the rule supersedes the language in the orange box).

Imperial dimensions are followed by comparable metric dimensions in parentheses to provide metric users with the approximate size, mass, etc. Metric conversions (e.g., dimensions) round to the nearest 0.05 cm, e.g., “17.5 in. (~44.45 cm).” The metric conversions are offered for convenient reference only and do not overrule or take the place of the imperial dimensions presented in this manual and the official drawings (i.e., dimensions and rules will always defer to measurements using imperial units).

Rules include colloquial language, also called headlines, in an effort to convey an abbreviated version of the rule or rule set. There are two versions of headline formatting. Evergreen rules, rules which are expected to go relatively unchanged from season to season, are indicated with their headline presented in ***bold green text** with a leading asterisk. “Relatively unchanged” means that the overall intent and presence of the rule from season to season is constant, but game specific terms may be updated as needed (e.g., changing Pixels to Samples in a rule about what DRIVE COACHES may not contact during a MATCH). These rules also start their respective section, so their rule number is less likely to change from season to season. All other rule headlines use **bold orange text**. Any disagreement between the specific language used in the rules and the colloquial

language is an error, and the specific rule language is the ultimate authority. If you discover a disparity, please let us know at customerservice@firstinspires.org.

Team resources that are not generally season specific (for example, what to expect at an event, communication resources, team organization recommendations, and award descriptions) can be found on the [FIRST Tech Challenge website](#).

1.7 Translations & Other Versions

The *FIRST* Tech Challenge Competition Manual is originally and officially written in English and is occasionally translated into other languages for the benefit of *FIRST* Tech Challenge teams whose native language may not be English. These assets are posted on the [Game and Season Materials](#) page.

A text-based English version can be provided only for use with assistive devices and not for redistribution. For more information, please contact *FIRST* Tech Challenge at customerservice@firstinspires.org.

Additional resources such as a [FIRST Tech Challenge AI Chatbot](#) are provided as a helpful tool, but the Competition Manual is the final authority. In the event that a rule or description is modified in an alternate version of this manual, the latest English PDF version as published on the [Game and Season Materials](#) page is the authoritative version.

1.8 Team Updates

Team Updates are used to notify the *FIRST* Tech Challenge community of revisions to the official season documentation (e.g., the manual, drawings) or important season news. Team Update posts are scheduled as follows:

- Every Thursday beginning on Kickoff day and ending two weeks prior to *FIRST* Championship.

Team Updates are posted on the Game and Season web page and are generally posted by 1pm Eastern.

Team Updates are indicated using the following formatting:

- Additions are highlighted in yellow. **This is an example.**
- Deletions are indicated with a strikethrough. ~~This is an example.~~

1.9 Question and Answer System

The [Question and Answer System \(Q&A\)](#) is a resource for teams to ask questions about gameplay, competition rules, judging and advancement, ROBOT build rules, and FIELD setup. Teams can search for previously asked questions and responses or pose new questions. Questions can include examples for clarity or reference multiple rules to understand the relationships and differences between them.

The Q&A opens on September 22, 2025, 12:00p.m. ET. Access to the Game Q&A forum is through the Lead Coach 1 or Lead Coach 2's account on the [FIRST dashboard](#). Follow the instructions on [how to create an official Q&A account](#). Teams may still create a separate view-only account to read the forum.

The Q&A may result in revisions to the text in the official manuals (which are communicated using the process described in section [1.8 Team Updates](#)).

Moderators will answer team questions beginning each Monday, and close on Thursday at 5:00pm ET. The responses in the Q&A do not supersede the text in the manual, although every effort will be made to eliminate

inconsistencies between the two. While responses provided in the Q&A may be used to aid discussion at each event, REFEREES and INSPECTORS are the ultimate authority on rules. If you have concerns about enforcement trends by volunteer authorities, please [notify FIRST](#).

The Q&A is not a resource for firm predictions on how a situation will play out at an event. Questions about the following may not be addressed:

- rulings on vague situations
- challenging decisions made at past events
- design reviews of a ROBOT system for legality
- questions that are overly broad, vague, and/or include no rule references

Some examples of questions that may not be answered in the Q&A are:

- how should the REFEREE have ruled when this specific gameplay happened?
- duplicate questions
- questions clearly defined/addressed in this manual

Good questions ask generically about features of parts or designs, gameplay scenarios, or rules, and often reference one or more relevant rules within the question. Some examples of questions that will likely be answered in the Q&A are:

- A device we are considering using on the ROBOT comes with purple AWG 40 wire, does this comply with R?? and R??
- We're not sure how to interpret Rule G?? applies if blue ROBOT A does X and red ROBOT B does Y, can you please clarify?
- If a ROBOT does this specific action, is it doing what this defined term is describing?

Questions from "FTC 1000" represent content asked by key volunteers (e.g., REFEREES, INSPECTORS), answered by *FIRST*, and are considered relevant to teams.



2 FIRST Season Overview



AGES 4-16

AGES 12-18

AGES 14-18

Ages may vary by region

FIRST

AGE

PRESENTED BY Qualcomm

Uncover the Future

FIRST® is the sport where every kid can go pro. As the world's leading non-profit that prepares young people for the future, FIRST offers a suite of life-changing youth robotics programs that build skills, confidence, and resilience. Participants work collaboratively to solve the annual, themed robotics challenge.

Every artifact we uncover holds a story. Each tool, each innovation, each work of art connects us to the people and ideas that came before us. Using STEM skills and teamwork, today we can dig deeper into discoveries than ever before.

Welcome to FIRST® AGE™ presented by Qualcomm, our 2025-2026 robotics season inspired by archaeology. What will you uncover? **Join us for an experience for the ages.**

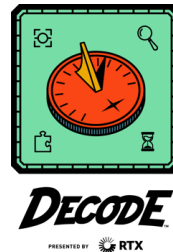

LEARN MORE: firstinspires.org/firstage

3 Competition Eligibility and Inspection (I)

3.1 Team Eligibility Rules

I101 ***Teams must be registered with FIRST.** Teams must be “competition ready” in order to compete in FIRST Tech Challenge official events and earn MATCH points or be eligible for judged awards.

- A. North America - competition ready requirements:
 - i. complete annual registration process through the FIRST dashboard
 - ii. pay annual registration fee
 - iii. 2 adults must be assigned in the Lead Coach 1/Lead Coach 2 roles and have passed [Youth Protection Program \(YPP\) screening](#), and
 - iv. complete any additional Youth Protection screening requirements (may vary from region to region).
 - v. register all youth team members on the FIRST dashboard
- B. outside North America - competition ready requirements:
 - i. complete annual registration process through the FIRST dashboard and
 - ii. complete any additional requirements by the local FIRST Program Delivery Partner with regards to program fees, registrations and youth protection screening.

The local Program Delivery Partner may, in rare cases, make exceptions for delayed payment on a case-by-case basis. Teams who have not paid annual registration fees will not earn any official season record and will not be allowed to advance.

I102 ***Check-in at the event on time.** Teams must check-in by the check-in deadline listed on the public event schedule or as instructed by the Event Director per [E105](#). Check-in must be completed by a team adult and at least one STUDENT must be present at the venue before check-in can be completed.

Additional check-in requirements will vary by region but may require one or more of the following items:

- A. A current, completed team roster from the team’s [FIRST dashboard](#) as specified by the local Program Delivery Partner,
- B. local Program Delivery Partner team member registration or consent forms (varies by region),
- C. a ROBOT built to play the current season’s game if they intend to participate in MATCHES, and
- D. printed team PORTFOLIO (optional, see section [6 Awards \(A\)](#))

All teams, regardless of how “ready” they think they are, are encouraged to participate in ROBOT MATCHES and judging. Teams are encouraged to reach out to their Program Delivery Partner and other teams to request help getting their ROBOT ready to compete before attending an event.

I103 ***A responsible adult must be present for the whole event.** At least 1, preferably 2, adult(s) responsible for the STUDENT team members must be present at all times during the event. Adults attending FIRST Tech Challenge events are expected to follow the same competition manual rules which dictate

behavioral norms as youth participants while also following the *FIRST* [Code of Conduct](#). Responsible adults must be listed on the team roster.

3.2 Awards Eligibility Rules

To be eligible for team judged awards a team must attend their assigned structured interview time ([A203](#)). For some awards submitting a PORTFOLIO as requested by the Event Director ([A202](#)) is also a required prerequisite. Complete details and rules about *FIRST* Tech Challenge awards can be found in section [6 Awards \(A\)](#).

3.3 MATCH Eligibility Rules

This section describes the rules governing MATCH participation. A team has participated in a MATCH if any member of their DRIVE TEAM is in the ALLIANCE AREA, with or without the ROBOT on the FIELD, at the start of the MATCH.

This section describes the rules and requirements for team participation in MATCH play. ROBOTS are required to pass ROBOT inspections before being allowed to compete. These inspections are to help ensure that all section [12 ROBOT Construction Rules \(R\)](#) are satisfied.

At each event, the Lead ROBOT INSPECTOR (LRI) has final authority on the legality of any COMPONENT, MECHANISM, or ROBOT. INSPECTORS may re-inspect ROBOTS at any time to ensure compliance with the rules. Teams are expected to consult with INSPECTORS or the LRI if they have any questions regarding the legality of a ROBOT or about how to make a ROBOT legal.

The inspection process may progress in blocks, i.e., it may pause for a team to make a correction or participate in a scheduled Practice MATCH. The process may employ various INSPECTORS throughout the process based on availability. At the team's discretion, they may request a different INSPECTOR or invite the LRI to participate in their ROBOT'S inspection.

ROBOTS are permitted to participate in scheduled Practice MATCHES prior to passing inspection. However, the FTA, LRI, or Head REFEREE may determine at any time that the ROBOT is unsafe and may prohibit further participation in Practice MATCHES until the condition is corrected and/or the ROBOT passes inspection.

Events may assign specific inspection time slots for teams to better facilitate a quick and orderly inspection process. Teams should plan to report to their assigned inspection times fully ready to complete inspection.

Prior to the start of a MATCH, any ROBOT which is unable or ineligible to participate in that MATCH, as determined by the team, *FIRST* Technical Advisor (FTA), LRI, or Head REFEREE, is DISABLED and can be removed from the FIELD with permission of the Head REFEREE or FTA. A team whose ROBOT is DISABLED or not present is eligible to receive Qualification MATCH Points or Playoff MATCH points provided that its ROBOT has passed inspection, per [I302](#), and as long as at least one STUDENT DRIVE TEAM member is present in the ALLIANCE AREA.

An [Inspection Checklist](#) is available to help teams self-inspect their ROBOT before their event. Teams are strongly encouraged to self-inspect prior to their event.

I301 *It is your team's ROBOT. The ROBOT and its MAJOR MECHANISMS must be built by the *FIRST* Tech Challenge team that has registered for the event and intends to use the ROBOT to participate in MATCHES or as part of judged awards.

A MAJOR MECHANISM is a group of COMPONENTS and/or MECHANISMS assembled together to address at least 1 game challenge: ROBOT movement, SCORING ELEMENT manipulation, FIELD element manipulation, or performance of a scorable task without the assistance of another ROBOT.

This rule requires that the ROBOT and its MAJOR MECHANISMS were built by its team but is not intended to prohibit or discourage assistance from other teams (e.g., fabricating elements, supporting construction, writing software, developing game strategy, contributing COMPONENTS, and/or MECHANISMS).

Examples that would generally not be considered MAJOR MECHANISMS, and thus are not subject to this rule include, but are not limited to, the following:

- A. a gearbox assembly,
- B. a COMPONENT or MECHANISM that is part of a MAJOR MECHANISM, or
- C. COTS items.

The intent of this rule is that a team's ROBOT is a product that's representative of the current team members' experience and is intended to discourage complete solutions which are provided wholly by outside organizations or companies. Also see [R301](#).

I302 *Enter only 1 ROBOT. Each team may only inspect and play MATCHES with 1 ROBOT at a *FIRST* Tech Challenge event. Each *FIRST* Tech Challenge team may only participate in 1 concurrent event at a time.

Violation: VERBAL WARNING. RED CARD if not corrected.

The intent of this rule is to use tournament resources responsibly by not requiring volunteers to inspect multiple ROBOTS and to prevent loopholes around having multiple inspected ROBOTS that can be switched out between MATCHES.

This rule does not prohibit teams from bringing other ROBOTS or robot-like assemblies into the venue for other purposes such as awards presentations or pit displays.

It is expected that teams will update, make changes and even build multiple ROBOTS in the course of a season, this rule only applies to bringing multiple different ROBOTS to a single event to play MATCHES.

I303 *Get inspected before playing a Qualification/Playoff MATCH. A team is only permitted to participate in a Qualification or Playoff MATCH and receive RANKING POINTS if their ROBOT has passed an initial, complete inspection. INSPECTORS are available to help, but teams are expected to ensure their ROBOT and other supporting equipment are within the rules at all times when competing.

Violation: If prior to the start of the MATCH, the team is DISQUALIFIED and not eligible to participate in the MATCH. If after the start of the MATCH, the team receives a RED CARD for that MATCH.

I304 *Bring the complete ROBOT and supporting equipment to inspection. At the time of inspection, the OPERATOR CONSOLE and the ROBOT with battery must be presented with all MECHANISMS (including all COMPONENTS of each MECHANISM), configurations, and decorations that will be used on the ROBOT in MATCHES without re-inspection per [I305](#).

- A. ROBOTS are allowed to play MATCHES with a subset of the mechanisms that were present during inspection. Only mechanisms that were present during inspection may be added, removed, or reconfigured between MATCHES. The ROBOT should be assembled in a typical configuration used for MATCH play when reporting for inspection. ROBOT and all mechanisms must be inspected in every STARTING CONFIGURATION.
- B. If MECHANISMS are swapped out between MATCHES, the reconfigured ROBOT must still meet all rules.
- C. The total of all electronics (motors, servos, Android Devices, etc.) used to build all mechanisms and base ROBOT, whether they are used on the ROBOT at the same time or not, may not exceed the constraints specified in section [12 ROBOT Construction Rules \(R\)](#).

I305 *Unless the change is listed below, any change to a ROBOT must get re-inspected. A ROBOT may play MATCHES with a subset of the MECHANISMS that were present during inspection provided the reconfigured ROBOT still complies with all ROBOT construction rules. Only MECHANISMS that were present during the inspection may be added, removed, or reconfigured between MATCHES without re-inspection per this rule. If a ROBOT is modified after its most recently passed inspection, it must be re-inspected before the ROBOT is eligible to participate in a MATCH.

Exceptions are listed below (unless they result in a significant change to the ROBOT'S size, legality, or safety).

- A. addition, relocation, or removal of fasteners (e.g., cable ties, tape, and rivets),
- B. addition, relocation, or removal of labeling or marking,
- C. addition, relocation, or replacement of the team SIGN,
- D. revision of ROBOT code,
- E. replacement of a COMPONENT with an identical COMPONENT,
- F. replacement of a MECHANISM with an identical MECHANISM (size, weight, material), and
- G. additions, removals, or reconfiguration of ROBOT with a subset of MECHANISMS already inspected per [I304](#)

Violation: ROBOT must be inspected before participating in a MATCH or the team will receive a RED CARD.

I306 *Do not exploit re-inspection. Teams may not use the re-inspection process in [I305](#) to circumvent any other rules.

I307 *ROBOTS may be powered on for inspection, as needed. Teams are allowed to power up and enable their ROBOT as part of the inspection process.

While in general it is good practice to keep a ROBOT powered off and in a configuration which minimizes stored energy whenever possible (e.g., springs relaxed), teams are allowed to power up and enable their robot as part of the

inspection process. Team members should let INSPECTORS know if the ROBOT must be powered on and/or enabled to meet any inspection criteria.

Team members should also inform INSPECTORS if the ROBOT in its inspection configuration has any stored energy (e.g., springs stretched) and collaborate with each other to ensure a safe inspection experience.

I308 ***STUDENTS must be present during the inspection process.** At least 1 STUDENT team member must accompany the ROBOT for any inspection efforts.

Exceptions may be made for major conflicts, e.g., religious holidays, major testing, transportation issues.

Violation: Inspection will not continue until a STUDENT is present.

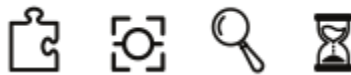

4 Advancement

Teams are only eligible to advance from events within their home region. Teams may be invited to compete at tournaments outside of their home region; however, they do so for the opportunity of additional gameplay and to compete with other teams from outside of their area and are not advancement eligible from these out-of-region events.

Teams can check what region they are assigned to on the [FTC-Events](#) page by looking up their team number. Teams in regions that do not have a local Program Delivery Partner, or who are geographically isolated within their home region can work with FIRST by emailing customerservice@firstinspires.org to get reassigned to another more accessible region once per season for advancement.

Figure 4-1: Region assignment display on FTC-Events page

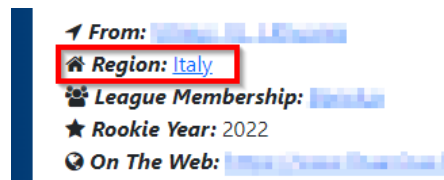

FIRST Tech Challenge tournament progression is shown in Figure 4-2. Teams can advance from any of their first three entry-level events: Qualifying Tournaments (QT) and League Tournaments (LT). Teams may only participate in one league per season. See section [14 League Play Tournaments \(L\)](#) for more details on League Tournaments. Teams may participate in more than 3 entry-level events but are not eligible to advance from them.

Figure 4-2: Tournament Advancement Structure

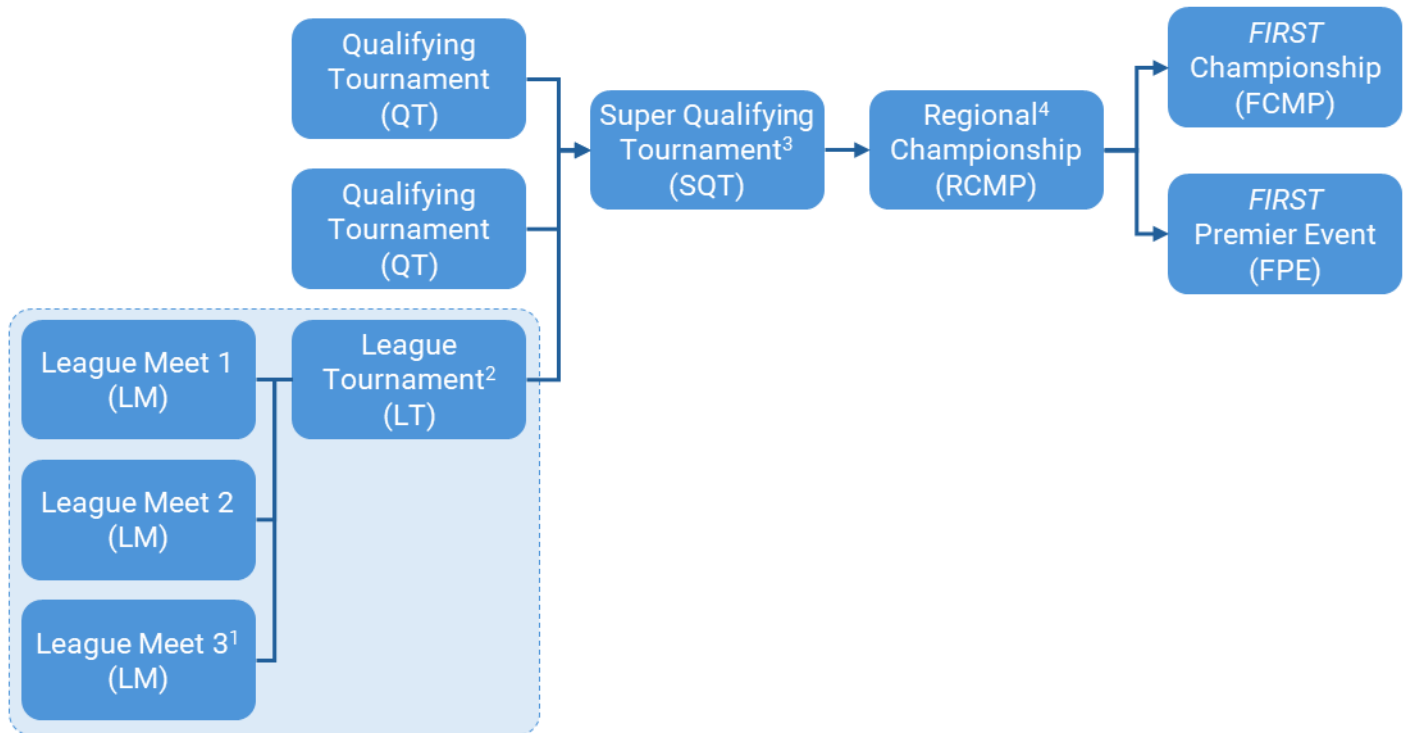

^{1,3} *Optional Events, not offered in all regions*

² *All teams within a League play in the League Tournament*

⁴ *Highest level of play within FIRST Tech Challenge Region. Can also be called State, Region, or Country Championship*

Teams may advance from their region’s Qualifying Tournaments or League Tournament to either a Super Qualifying Tournament (SQT) or directly to a Regional Championship (RCMP). Super Qualifying Tournaments (SQT) are an optional advancement level often used in large regions which need more levels of competition. A team may only participate in one Super Qualifying Tournament(SQT).

The local Program Delivery Partner determines the advancement numbers from each tournament in their region, up to a Regional Championship. FIRST Staff determine the advancement from each Regional Championship to the FIRST Championship and FIRST Premier Events.

4.1 Advancement Points Calculation

For each advancing event, teams will be ranked based on the advancement points they earn through their overall performance at that individual event. The top ranked teams not already advanced will qualify for the next level of play, up to the total allocated advancement spots for that event. Advancement points are awarded to teams based on Table 4-1 below.

Table 4-1: Advancement Point Assignment

Category	Advancement Points Earned
Qualification Phase Performance	Normal distribution of points from 16 to 2 across the highest ranked team to the lowest based on the equation in section 4.1.1 Qualification Phase Performance . (This will result in a minimum of 2 points and a maximum of 16 points being awarded for qualification phase performance.)
ALLIANCE lead	Equal to 21 minus the ALLIANCE lead number (e.g., 18 points for ALLIANCE #3 lead)
Draft Order Acceptance	Equal to 21 minus the Draft Order Acceptance number (e.g., 18 points for the team which accepts the third draft position)
Playoff Advancement	40 points for 1 st Place (Winners) 20 points for 2 nd Place (Finalists) 10 points for 3 rd Place 5 points for 4 th Place (See Section 13.8 Dual Division Events for modifications to this section)
Team Judged Awards	60 points for Inspire Award 1 st Place 30 points for Inspire Award 2 nd Place 15 points for Inspire Award 3 rd Place 12 points for all other 1 st Place Awards 6 points for all other 2 nd Place Awards 3 points for all other 3 rd Place Awards (See A211 for a list of points-eligible awards)

If there is a tie in the point totals between teams, the higher ranked team will be determined using the following additional sorting criteria in Table 4-2.

Table 4-2 Advancement Sorting Criteria Including Tiebreakers

Order Sort	Criteria
1 st	Total Advancement Points (as calculated in Table 4-1)
2 nd	Judged Team Award Points
3 rd	Playoff Advancement Points
4 th	ALLIANCE Selection Results Points (ALLIANCE lead or Draft Order Acceptance)
5 th	Qualification Phase Performance Points
6 th	Average Qualification MATCH Points (excluding FOULS)
7 th	Average Qualification AUTO Points
8 th	Highest individual Qualification MATCH Points (excluding FOULS)
9 th	Second Highest individual Qualification MATCH Points (excluding FOULS)
10 th	Random Selection by Event Management System

4.1.1 Qualification Phase Performance

The calculation of Qualification Phase Performance points is done using the equation below. This equation is an inverse error function which utilizes the following variables:

- **R** – the qualification rank of the team at the event at the conclusion of Qualification MATCHES (as reported by the Event Management Software and defined in Section [13.6.3 Qualification Ranking](#))
- **N** – the number of FIRST Tech Challenge teams participating in the Qualification rounds at the event
- **Alpha (α)** – a static value (1.07) used to standardize the distribution of points at events

$$QualificationPoints(R, N, \alpha) = \left[InvERF\left(\frac{N - 2R + 2}{\alpha N}\right) \left(\frac{7}{InvERF\left(\frac{1}{\alpha}\right)}\right) + 9 \right]$$

This formula generates an approximately normal distribution of Qualification Phase Performance points at an event, based on rank, with most teams getting a moderate number of points, and fewer teams getting the highest or lowest numbers of points available.

Table 4-3 displays sample Qualification Phase Performance points for variously ranked teams at a 28-team event. The system will automatically generate the appropriate points for each team based on their rank and the number of teams at the event.

Table 4-3 Sample Qualification Round Point Assignments

Rank	1	2	3	4	...	12	13	14	...	25	26	27	28
Points	16	15	14	14	...	10	10	10	...	6	5	5	4

4.1.2 ALLIANCE Selection Results

This attribute measures both individual team Qualification round seeding performance and recognition by peers.

ALLIANCE leads are recognized based on their Qualification phase seeding rank. This rank is a result of the rules of the game, which typically incorporate several team performance attributes, and are designed to eliminate ties in rank. ALLIANCE partners are rewarded based on peer recognition. To be invited to join an ALLIANCE, a team’s peers have decided that the team has attributes that are desirable. Giving points for ALLIANCE selection also supports come-from-behind teams. A team taking several MATCHES to optimize their performance may be recognized as a late bloomer by a top seeded team, even if that performance isn’t reflected in the rankings because of poor performance in early MATCHES. These points also have the potential to recognize teams employing a unique strategy with their ROBOT. Teams with unique or divergent ROBOT capabilities that complement the strengths of other ALLIANCE members may be selected to fill a strategic niche.

Note also that ALLIANCE leads are given the same number of points as the team drafted in the same sequence. For example, the team who accepts the pick from the 3rd ALLIANCE lead receives the same number of points as the 3rd ALLIANCE lead. Numerical analysis supports the idea that ALLIANCE leads are about as strong in ROBOT performance as equivalently drafted teams. An additional minor benefit to this system is that it allows teams who would traditionally not be a top ranked team the opportunity to be an ALLIANCE lead.

4.1.3 Playoff Performance

This attribute measures team performance as part of an ALLIANCE.

Teams earn points based on how far they progress into the Playoffs. Points are given to all teams within the ALLIANCE as described in Table 4-1.

See Section [13.7.2 Playoff MATCH Bracket](#) for more details on the number of ALLIANCES that are formed for the Playoffs and an example of the Playoff MATCH bracket.

4.1.4 Team Judged Awards

This attribute measures team performance with respect to team awards judged at the event.

The points earned for team awards in this system are not intended to capture the full value of the award to the team winning the award, or to represent the full value of the award to FIRST. In many ways, the team’s experience in being selected for awards, especially the Inspire Award, is beyond measure, and could not be fully captured in its entirety by any points-based system. Points are being assigned to awards in this system only to help teams recognize that FIRST continues to be “More than Robots®,” and to assist in elevating award-winning teams above non-award-winning teams in the ranking system.

Teams only get points for team awards judged at the event. If an award is not judged, is not for a team (e.g., the *FIRST* Leadership Award), or is not judged at the event (e.g., Safety Animation Award), no points are earned. Points for awards not given at the event are not assigned to any team. See [A211](#) for the list of points-eligible awards.

4.2 Advancement Distribution by Region

Advancement within a region is determined by the Program Delivery Partner and minimum advancement numbers should be made publicly accessible to participating teams as early as possible before the event, and no later than when ALLIANCE selection begins. Advancement information may be published on the [FTC-Events](#) page as shown in Figure 4-3.

Figure 4-3 Event Advancement Information as shown on the ftc-events.firstinspires.org/ page

Event Information	
Basic information about the NYC QUALIFIER 1 can be found in the chart below. All times and dates displayed here and on the event's individual result pages are local to the event.	
Event Code	USNYNYNYQ
Dates	 Event Complete (Week 11 since kickoff) Sunday, November 17 to Sunday, 17 November 2024
Venue	East Harlem Tutorial Scholars Academy 2017 FIRST Avenue New York, NY USA
Region	New York - NYC
Advancement	8 teams advance to NYC SUPER QUALIFIER 2
Website	https://www.eastharlemscholars.org/high-school

Advancement to the *FIRST* Championship and *FIRST* Premier Events is determined by *FIRST* Headquarters based on a number of factors including:

- Number of teams registered within the region before the cutoff date (this season November 17th)
 - Regions who meet minimum registration requirements
 - Total number of teams within the region
- New developing regions with a Program Delivery Partner
- Global and regional representation

Regional allocations of advancement slots information will be published on the [FTC-Events](#) page starting in early December. Regionally allocated slots which are not secured by the event deadline will be returned to *FIRST* HQ or Premier Event Host for reallocation which may include reallocation to a new region or waitlist team invitation.

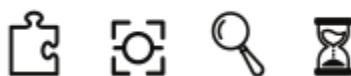

5 Event Rules (E)

This section includes general rules which apply from the beginning of the public schedule when teams arrive through the end of the event with departure from the venue. These are high-level rules intended to promote an orderly and safe experience for all participants. The Event Director may specify additional restrictions beyond those listed here based on local venue requirements which in most circumstances will be communicated to teams in advance of the event.

Universal Violation Note: A violation of any [Event Rules \(E\)](#) will result in a warning from event volunteers. Egregious or repeated violations of an Event Rule will be addressed with a VERBAL WARNING from the Head REFEREE, the Lead ROBOT INSPECTOR (LRI) and/or Event Director. Subsequent violations of an Event Rule may result in escalation to FIRST Headquarters and/or disqualification for the team from MATCHES and awards. Criminal behavior will not be tolerated and will result in removal of individual(s) involved and/or disqualification for the team from the event.

Any items that are deemed unsafe or outside specifications by FIRST personnel and/or the Event Director must be removed.

Additional rule specific violations, if applicable, are listed with their corresponding rule.

FIRST is committed to [STEM for Everyone](#)™ and as such, FIRST strives to make reasonable accommodations for persons with disabilities that request accommodation. If a participant needs an accommodation for an event, we ask that they talk to a volunteer at the event or contact their [local leadership](#) before the event so they can ensure the request is addressed. Accommodations are considered reasonable if they do not create an undue hardship, cause safety concerns, or fundamentally alter the nature of the event.

Rules around safety and security within this section are minimum requirements, and Program Delivery Partners are able to implement increased restrictions due to local or venue requirements (e.g., requiring badging for all attendees, reserving seating for accessibility). Partners should communicate additional local requirements early enough to allow teams to plan.

Safety is always paramount, and many rules are intended to establish norms at each event that will mitigate injury risk to all participants.

The Event Director has the final decision authority for all safety-related issues within a venue.

5.1 General Rules

E101 ***Personal safety comes first.** All team members must observe the following safety practices throughout the event:

- A. wear safety glasses or safety rated glasses with side shields (ANSI-approved, UL Listed, CE EN166 rated, AS/NZS certified, or CSA rated) while in and around the playing FIELD and in the pit area. Clear or lightly tinted safety glasses are preferred. Shaded glasses are allowed for those who need them and do not require a specific accommodation request. The only instances where teams are not required to wear safety glasses are in their first 10 minutes

- of their event load in, and for the first 10 minutes pits are open each day of the event as long as they're not working on the ROBOT or setting up their pit,
- B. wear closed toed/heeled shoes,
 - C. control entanglement risks by tying back long hair and removing other dangling decorations including lanyards, spirit wear and rings as needed while working on or around a ROBOT or ROBOT related materials or tools,
 - D. wear appropriate clothing,
 - E. walk in the venue, and
 - F. comply with government and venue-specific health and safety requirements in place for that event (i.e., mask wearing).

Teams are responsible for bringing their own personal protective equipment.

For more information about safety at *FIRST* events, please reference the [FIRST Safety Manual](#).

A partial list of footwear that is not allowed: Crocs, slides, sandals, flip flops, Birkenstocks, sandals with an ankle strap, clogs.

- E102 *Be Nice.** All participants should strive to be gracious and professional at all times while attending a *FIRST* Tech Challenge event. Uncivil behavior toward any participants is not tolerated.

Examples of inappropriate behavior include, but are not limited to:

- A. use of offensive language or other uncivil conduct towards someone,
- B. “weaponizing Gracious Professionalism” by accusing another person or team of being “not GP”,
- C. intentionally blocking the view of other participants or spectators for an extended period (Team members momentarily holding up team signs while directly supporting their team is not considered a violation of this rule.), and
- D. jamming or interfering with the remote sensing capabilities of a ROBOT or the FIELD while in open-access spectator seating areas.

Examples of remote sensing capabilities include, but are not limited to, vision systems, acoustic range finders, sonars, and infrared proximity sensors.

Use of imagery that, to a reasonably astute observer, mimics the AprilTags employed on the FIELD is a violation of this rule.

Examples of particularly contemptible behavior that may result in ejection from the event include, but are not limited to, the following:

- E. assault, e.g., throwing something that hits another person (even if unintended),
- F. threat, e.g., saying something like “if you don’t reverse that call, I’ll make you regret it,”
- G. harassment, e.g., badgering someone with no new information after a decision has been made or a question has been answered,
- H. bullying, e.g., using body or verbal language to cause another person to feel inadequate or unsafe,

- I. insulting, e.g., telling someone they do not deserve to be on a team,
- J. swearing at another person (versus swearing under one's breath or at oneself), and
- K. yelling at another person(s) in anger or frustration.

- E103** ***Children with adults, please.** Children under 12 must be accompanied in the pits by an adult at all times.
- E104** ***Respect the venue.** Teams may not damage the venue, including but not limited to bleachers, floors, walls, railings, in any way. This includes littering with team giveaways including candies, flyers, and stickers.
- E105** ***Teams must check in.** An adult team member must check in at the Pit Administration station, or the designated check in location, no later than 45 minutes before Qualification MATCHES are scheduled to start unless otherwise specified or approved by the Event Director.

Violation: Failure to check in may result in a team not participating in the event.

- E106** ***Event resources are for competing teams only.** Only teams registered for an event may use that event's competition FIELD, practice FIELD, and inspection unless pre-approved by the Event Director or the Program Delivery Partner. Host teams supplying practice FIELD elements and/or machine shop resources may use them; however, teams registered for that event must be granted priority.
- E107** ***Practice only when/where permitted.** Teams may only practice with their ROBOT in their pit space, in the designated event practice areas, or while in a Practice MATCH.

Teams may not set up their own practice equipment outside their pit in other areas of the event venue. If the Event Director determines a pit practice setup is unsafe or interferes with activity in adjacent pits or aisles, the team must discontinue the activity.

Demonstrating robot functionality to guests or JUDGES is not considered practice.

- E108** ***Work in designated areas only.** At the event venue, teams may only produce FABRICATED ITEMS as follows:
- A. in their pit area,
 - B. in another team's pit area with permission from that team,
 - C. while queued for a MATCH or practice FIELD (given space constraints, extra scrutiny regarding safety is required),
 - D. any area designated by event staff (e.g., playoff pit area), or
 - E. as permitted at provided machine shops that are available to all teams.
- E109** ***Some things do not belong at events.** Do not bring or use the following:
- A. Skateboards,
 - B. 'hoverboards',
 - C. drones,
 - D. bottled gas tanks (e.g., helium),
 - E. noisy devices or noisemakers, such as floor stompers, whistles and/or air horns,

- F. walkie-talkies, or
- G. scooters, except for those used for accommodations.

- E110** ***Do not arrange for additional utilities.** Do not arrange for power, internet access, or phone lines from venue service providers or attempt to use venue internet connections reserved for event purposes (e.g., *FIRST* event management software or webcasting).
- E111** ***Do not sell stuff.** Teams may not conduct sales at an event. This includes, but is not limited to, raffle tickets, food, hats, shirts, candy, water, soft drinks, fruit, or any promotional products unless specifically allowed by the Event Director.
- E112** ***Make *FIRST* loud, but with restrictions.** Do not invite or bring live bands to play in the audience. Do not play loud music.
- E113** ***Hang banners with care.** Be respectful when hanging your banners.
- A. Do not cover or move other team or sponsor signs already in place.
 - B. Share the available space fairly with other teams.
 - C. Do not obstruct the view of spectators.
 - D. Get permission from the Event Director before hanging banners outside of your pit.
 - E. Hang signs and banners in a safe manner.
 - F. Banners hung outside team pits must not be larger than 25 ft.2 (2.3 m2).

We encourage teams to bring team flags and/or signs for display in their pits and/or the ARENA.

Respect venue-specific rules regarding sign location and hanging methods. At the end of the event, safely remove all signs and anything used to hang the signs (tape, string, etc.).

- E114** ***Limit flag and flagpole size if used in the ARENA.** Flags and flagpoles may not be of unreasonable size and weight if they are going to be used around the FIELD.

As a guideline, reasonable flags are less than 3 ft. by 5 ft. (~91 cm by 152 cm) in size and weigh less than 2 lbs. (~907g). Reasonable flagpoles may not be more than 8 ft. (~243 cm) long and must weigh less than 3 lbs. (~1360g).

- E115** ***No firearms or other weapons.** Firearms or other weapons are prohibited at all *FIRST* events for all *FIRST* programs, including without limitation, [all official *FIRST* Events posted here](#). This rule includes prop or simulated weapons which appear to be real. This policy does not apply to law enforcement or venue security personnel.
- E116** ***Inspection required for practice FIELD access.** A team may only use a practice FIELD with a ROBOT that has passed an initial, complete inspection. This rule only applies to events not using scheduled inspection times.
- E117** ***Do not record anyone at the event without their consent.** Do not record interactions with anyone at an event, without the person's consent. *FIRST* event staff and volunteers are empowered to excuse themselves from an interaction in which they are being recorded after declining consent.

Please note that many *FIRST* events are livestreamed and *FIRST* participants have given permission to appear in footage from *FIRST*. This does not mean that people can record specific interactions without additional consent.

Laws regarding recording of conversations vary state-to-state and country-to-country, and, in some cases, recording without consent may be criminal. Introducing the idea of recording a conversation with an implied reason of proving someone's error can escalate a discussion and is likely to increase its adversarial nature.

5.2 Machine Shops and Host Team Build Spaces

Rarely, some events host a machine shop or open their team's build space, during specific hours (see the event public agenda), to help teams with repair and fabrication of their ROBOT. Machine shops are typically sponsored by the local host organization. In most cases, the machine shop is on site and readily accessible to all teams. All competing teams should have access to the same resources.

5.3 Wireless Rules

E301 *No wireless communication. Teams may not set up their own Wi-Fi (802.11a/b/g/n/ac/ax/be) wireless communication (e.g., access points or ad-hoc networks), Bluetooth, or any other communications systems using 2.4GHz or 5GHz wireless in the venue.

A wireless hot spot created by a cellular device, camera, smart TV, etc. is considered an access point.

Some smart TVs have access points enabled by factory default. Please make sure that functionality is disabled for any TVs brought to the event.

Bluetooth uses 2.4GHz frequencies to communicate which can interfere with venue and ROBOT systems.

Many R/C toys (including drones, wireless vehicles, FPV systems) use 2.4GHz and 5GHz communications. Do not operate these in the venue.

E302 *Don't interfere with wireless networks. Participants may not interfere, attempt to interfere, or attempt to connect with any other team or *FIRST* wireless network without expressed permission.

Teams are encouraged to report suspected wireless security vulnerabilities to the *FIRST* Technical Advisor (FTA) or Event Director if at the event or to *FIRST* via customerservice@firstinspires.org to report a suspected issue after the event.

5.4 Load-In

Some large events (often multi-day events) may set specific time frames, published on the event public schedule, in which teams are invited to load their ROBOT and equipment into their pit areas before pits officially open.

Load-in can be stressful for teams and volunteers, which can be mitigated by preparation and planning. Unanticipated factors, like traffic or weather, can change a team's scheduled arrival time, making the process

difficult. The most important things a team should remember are to be safe, gracious, and professional. Teams who experience smooth and easy load-ins are encouraged to check with others to see if they can help and make their experience as positive as possible.

5.5 Pits

A team pit is the designated space, typically a 10 ft. by 10 ft. by 10 ft. (~3 m x 3 m x 3 m) area, where a team may work on their ROBOT. Each team is assigned a pit space typically marked with their team number. This helps team members, JUDGES, and visitors find teams easily. Pit spaces may vary based on competition venue size limits.

The pit area refers to the general area where team pits are located which encompasses the aisles between the pits, pit admin, ROBOT inspection, practice FIELD, or other areas where ROBOTS may be active or worked on. All pit rules apply to the full pit area.

Additional limitations beyond those listed below may be imposed by the Event Director but they should be clearly communicated at least 48 hours before the event start time and applied to all teams fairly. Team pits may or may not have a table and power outlet. If individual team outlets are not provided, the venue must provide access to team-usable outlets in the pit area for charging batteries. Power may not be available overnight for a multi-day event.

Teams, volunteers, FIRST staff, and guests spend a lot of time in the pits. Get to know other teams and help each other when you can. Time is short and help is very often right "next door" in the adjacent team pits.

Small, bench-top machinery, with appropriate guards, is permitted in team pits. 'Small' machinery is machinery that can be easily lifted by one person and examples include, but are not limited to: 3D printers, small band saws, small drill presses, desktop CNC mills, and sanders.

E501 *Pits are unavailable if closed. Teams may not access their pit area outside the designated hours.

E502 *Stay in your pit. Teams should set up their allowed equipment fully within their assigned pit space. Teams may not:

- A. run power or internet lines from their team pit to any other area except as instructed or allowed by the Event Director,
- B. swap team pits with other teams if pits have assigned team numbers, or
- C. move themselves to empty team pits without Event Director approval.

E503 *Keep aisles clear. Aisles must be kept clear.

E504 *No sparks or flames. Tools that throw sparks or produce open flames are prohibited.

Examples of tools that violate this rule include, but are not limited to: welders, bench and angle grinders, and gas torches.

E505 *Nothing too big. Floor standing power tools are prohibited.

Examples include, but are not limited to: full-size drill presses, and band saws.

E506 *No brazing or welding. Brazing/welding is prohibited.

-
- E507 *Solder with specific tools only.** Soldering may be done using an electric iron/gun only.
- E508 *Structures must be safe.** Teams may not build any structure that supports the weight of people or stores items overhead. Structures may not block or inhibit fire sprinkler systems or otherwise be unsafe.
- E509 *Secure team identification assets.** Team signs, flags, and displays must be securely mounted to the pit structure.
- E510 *Only use aerosol or other chemicals with noxious fumes in approved areas.** Any aerosol or chemical that produces noxious fumes or spray particulates should only be used in approved areas. Not all venues will allow the use of these products anywhere on site.

5.6 ROBOT Carts

Most teams use carts to transport their ROBOT throughout an event. Carts are not required but are recommended (to minimize risk of muscle strains, dropped ROBOTS, and other hazards). In addition to the rules listed below, teams are encouraged to put the team's number on the cart, refer to the [FIRST Safety Manual](#) for key safety guidelines and practices.

- E601** ***Carts must be safe and easy to use.** Carts must be easy to control, maneuver, and pose no risk to bystanders.
- E602** ***Carts should not be too big.** Carts must fit through a standard 30-inch door.
- E603** ***Carts cannot park anywhere.** Carts must remain in the team pit (or other venue designated cart staging areas) when not in use.
- E604** ***No noisy carts.** Carts may not be equipped with music or other sound-generating devices.
- E605** ***No motor driven carts.** ROBOT carts may not use powered propulsion.

5.7 Ceremonies

At most events, there are opening and closing ceremonies to show honor and respect for represented countries, sponsors, teams, mentors, volunteers, and award winners. Ceremonies provide everyone with the opportunity to collectively applaud the successes of all participants. They also give teams a chance to "meet" the volunteers and other people and sponsors involved with the event. Closing ceremony elements are at the end of most events and are integrated into and presented between Playoff MATCHES.

At the awards ceremony, *FIRST* presents trophies and medallions to outstanding teams. All team members are encouraged to attend the ceremonies, be punctual, and show appreciation to volunteers that staffed the event.

- E701** ***Quiet in the pits during ceremonies.** During ceremonies outside of Playoff MATCHES, team members may not:
 - A. use power tools
 - B. use loud hand tools (hammers, saws, etc.), or
 - C. shout, yell, or use loud voices, unless as a demonstration of approval during a ceremonial activity.
- E702** ***Pit person limit during ceremonies is 5.** No more than 5 team members may be in the pits during ceremonies outside of Playoff MATCHES. Each team must have at least 1 representative observing ceremonies to be responsible for relaying important information to the entire team.

All teams are encouraged to have as many people in the stands for ceremonies as possible. This is important both to celebrate all who are recognized during ceremonies, but also to listen for important day-of information from event organizers which might be critical for your team.

- E703** ***Be respectful during anthems.** Team members, including any remaining in the pits, should exhibit peaceful behavior during the presentation of all national anthems. If team members wish to abstain from traditional anthem observance behaviors, they have a right to do so, as long as they remain silent and non-disruptive.

5.8 In the Stands

E801 *No saving seats. Teams are not permitted to save or designate seats for team members that are not actively using them.

Teams may not hang banners or ribbons or otherwise designate seating. (Event staff will remove and discard any banners, roping, etc., used to designate seating.) Please take turns sitting in the bleachers/stands if seating is limited. If there is a crowding problem, we ask that you kindly leave after your team's MATCH and return later, if possible.

The Event Director may reserve seats for attendees who require accessible seating, for certain volunteers, or to ensure teams in the Playoffs have seats to watch their teams play.

E802 *No throwing items from the stands. Items may not be thrown from the audience seating.

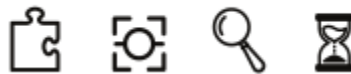

6 Awards (A)

FIRST Tech Challenge celebrates the excitement of competition both on and off the field. Through the following awards, we celebrate the *FIRST* Core Values which makes us so much “More than Robots”. Please note that different event types (e.g., League Tournaments, Regional Championship, *FIRST* Championship) or event sizes may offer different sets of awards. Not every award is presented at every *FIRST* Tech Challenge event. No awards are presented at League Meets, see section [14 League Play Tournaments \(L\)](#), additional details by event type are available in the sections below.

Judged awards are determined by volunteers from the community who prepare for the event with thorough training and certification. There are two key judging volunteer roles:

- JUDGES – meet with teams to learn about and celebrate the unique journey and accomplishments of each team and evaluate these against award requirements. JUDGES interact with STUDENTS during the interview process, and in the pits. As a group, JUDGES determine the teams that receive awards at events.
- JUDGE Advisor (JA) – trains, directs, and supervises JUDGES throughout the event. JUDGE Advisors oversee the judging processes and procedures to make sure they are in accordance with *FIRST* Tech Challenge judging guidelines.

FIRST Tech Challenge judging is delivered in one of two ways. Most events will have in-person (“traditional”) judging along with the standard in-person gameplay. The second is hybrid format which has in-person gameplay, but judging is done remotely before in-person gameplay. This manual will primarily describe the traditional in person judging process. The remote judging process follows the same overall judging standards and requirements, but interviews are conducted online, and in-person meetings may not occur.

Teams may also read the [Judge and Judge Advisor Manuals](#) to gain more insight into the complete judging process. Teams are also encouraged to review the [Outreach Terms and Definitions Document](#) to ensure all teams can clearly communicate with judges and our community the great things they do to grow *FIRST*.

6.1 Team Judged Awards Overview and Schedule

Most *FIRST* Tech Challenge awards fall into two broad categories: Machine, Creativity, and Innovation (MCI), and Team Attributes (TA). In addition to MCI and TA awards, there are also two other separate awards, the Think Award and the Judges’ Choice Award. The final award is the Inspire Award which is a special overarching award (Figure 6-1). The local Program Delivery Partner may elect to give additional awards to celebrate local sponsors or initiatives, but these awards are not considered Team Judged Awards for the purposes of advancement calculations as described in Section [4 Advancement](#).

Figure 6-1: Award hierarchy

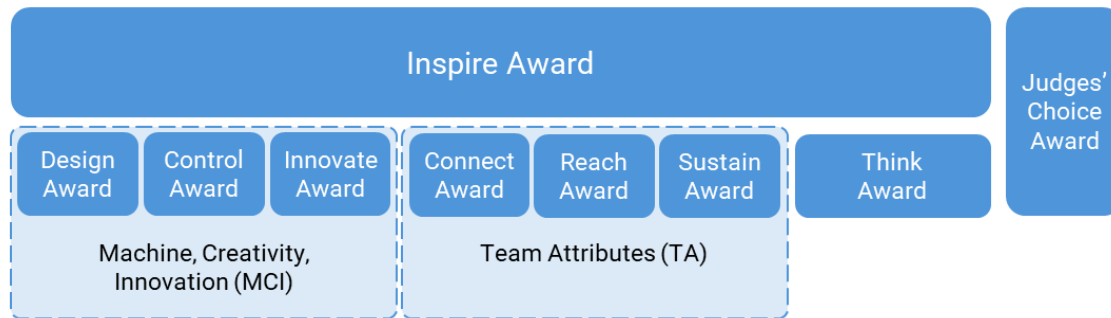

- The **Inspire Award** recognizes teams who excel in MCI, TA, and Think award accomplishments. This team is an all-around inspiration for others.
- **MCI awards** recognize the technical accomplishments of teams in the brainstorming, design, construction, operation, and control of their ROBOTS.
- **TA awards** recognize teams who have expanded their skillset, created a plan to sustain their program and team, and spread the message of *FIRST* throughout their outreach.
- The **Think Award** recognizes teams who masterfully document their team’s process and ROBOT using their PORTFOLIO.
- **Judges’ Choice Award** recognizes a team whose unique efforts, performance, or dynamics merit recognition, but does not fit into any of the other award categories.

The JUDGES will gather information from the teams through several different pathways (Figure 6-2). All teams will have the opportunity to submit a team PORTFOLIO which should document aspects of their team which directly support the judged award criteria or information which they wish the JUDGES to consider. Teams can participate in two different types of interviews: a structured interview and pit interview(s).

All award winners chosen by the JUDGES are recognized as being positive examples of the award criteria, not necessarily the “best” team. JUDGES will only consider the published award criteria in section [6.3 Team Judged Award Descriptions](#).

Teams may participate in judging regardless of the inspection status of their ROBOT and are eligible for awards even if they are attending the event without a ROBOT.

6.1.1 Sources of Information Considered for Awards

In addition to the information provided in a team’s PORTFOLIO (if submitted) and the interviews, JUDGE Advisors may also accept feedback about teams at the event from other volunteers to help inform their understanding of the team. All of the sources in Figure 6-2 help JUDGE Advisors facilitate discussions with JUDGES when award deliberations begin.

Figure 6-2: Sources of Information for Team Judged Awards.

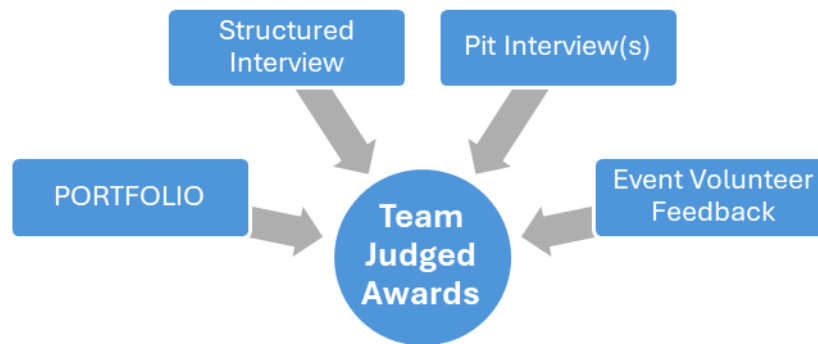

In addition to the specific information sources JUDGES use to evaluate teams, there are also sources of information which are specifically disallowed. JUDGES are strictly instructed to only consider information from the current event and the current season and cannot consider information from outside what they have seen or heard at the current event.

Per [A201.E](#), progress, challenges, and accomplishments which have taken place since January 1, 2025, can be documented in the team PORTFOLIO and will be considered as part of the current season.

This means that information like past performance (good or bad), personal knowledge of a team, and external sources like websites and social media are not considered. JUDGES also do not consider ROBOT performance (for example, how many scoring tasks are completed) in an award unless it is specifically listed as part of the required or encouraged evaluation criteria. A team’s ROBOT placement in a competition (winner or finalist, etc.) or qualification ranking is not considered when evaluating teams for a judged award.

The awards are a method *FIRST* uses to inspire STUDENTS and open their eyes to building a better future together. The awards process should foster a positive STUDENT interaction with JUDGES who are independent caring adults and can recognize their achievements and encourage them to continue learning.

6.1.2 Structured Interview

All teams are encouraged to prepare for a structured interview session where the team can present a prepared oral presentation to a small panel of JUDGES, followed by a Q&A session. Typically, these interviews follow a standard timeline (Figure 6-3) and last at least 10 minutes long, per [A205](#).

Instead of the structured interview, interviews conducted at the *FIRST* Championship have a different format. Teams should refer to the interview format outlined in [Section 15.1.2](#) for more details.

Figure 6-3: Structured Interview Timeline



1. Team arrives and JUDGES welcome the team.
2. Teams may present to the JUDGES uninterrupted for up to 5 minutes.
3. JUDGES will ask open ended questions to the team for the remaining of the scheduled structured interview time.
4. Team departs from the interview space.
5. JUDGES discuss the structured interview and complete the feedback form.
6. JUDGES welcome the next team into the structured interview location and repeat the process.

Teams are encouraged to review the [Judge Interview Question Bank](#) prior to their judging interviews to understand the type of questions that may be asked by the JUDGES. At each event, the JUDGE Advisor will select two questions from the question bank that all teams will be asked at the start of the structured interview's question and answer session. One question will be focused on the MCI award category, and one question will be focused on the TA award category. After the first two questions are asked and answered, JUDGES may ask additional questions to help evaluate the team's performance against the award criteria.

Additional questions asked during interviews may come from the question bank but teams should be prepared to answer questions that are not listed within the document.

6.1.3 Pit Interview(s)

After all the judging panels have finished, the JUDGES compare notes and may elect to follow up with the teams in the pit area during the competition and conduct informal pit interviews. During pit interviews, teams have the opportunity to expand upon materials presented in the structured interview and share additional content with the JUDGES (for example, ROBOT prototypes, design artifacts, and photos or letters from outreach events). A team does not need to prepare another presentation for a pit interview but should be ready to answer questions from the JUDGES.

JUDGES may read additional information during pit interviews but will not bring back additional printed content to be referenced as part of the JUDGE deliberations.

6.1.4 Sustained Outreach and Demonstrating Impact by Numbers

In general, JUDGES will consider ongoing, sustained outreach to be of higher quality than occasional or one-off outreach. JUDGES will seek to understand what is the impact of the outreach to the individuals being reached by the activity.

Teams are encouraged to review the [Outreach Terms and Definitions Document](#) to understand the requirements behind specific terms (starting a *FIRST* team, running an event, reaching x number of people). JUDGES may ask specific questions when a specific term listed in this document is mentioned in a team's PORTFOLIO or during an interview.

6.2 Team Judged Award Rules

This section outlines rules for in-person judging of Team Judged Awards. Modifications for the judging process at the *FIRST* Championship can be found in [Section 15.1](#).

A201 *Team PORTFOLIOS have limits. Teams have the opportunity to submit a team PORTFOLIO to be used as part of the judging process. No other printed or digital content not directly included in this document will be collected by the JUDGES to consider during deliberations. Team PORTFOLIOS must meet the following requirements:

- A. must consist of 1 cover page including the team number and optionally: team name, PORTFOLIO table of contents, team organizations, sponsors, logo, motto, and picture of the ROBOT and/or team,
- B. no more than 15 pages of content,
- C. use only US Letter (8.5" x 11") or A4 (210 x 297 mm) size pages,
- D. if submitted digitally, the complete submission must be less than 15MB in size, and
- E. must only include progress, challenges, and accomplishments which have taken place since January 1, 2025.

None of the content of the cover page will be used by JUDGES to evaluate any awards criteria. Any content beyond the allowed 15 pages will not be reviewed by the JUDGES.

Teams are encouraged to limit Personally Identifying Information (PII) in the PORTFOLIO. Best practices would be to use only first names and optionally last initials of STUDENTS. Photographs including images of STUDENT team members are acceptable. The JUDGES use the cover page to identify the team associated with the PORTFOLIO. Teams who forget to include a cover page may be disqualified from judging if the JUDGES cannot determine what team the PORTFOLIO is associated with.

Teams should carefully consider font size, color, and graphic design when making their PORTFOLIO so that all JUDGES are able to read their submission. Teams whose design choices include small fonts (<10 pt) or low contrast text on images will not be excluded from consideration but understand that JUDGES will not be able to use anything they cannot read. Teams can use various free

accessibility tools, like [WebAIM Contrast Checker](#), to help them design with readability in mind.

JUDGES will not open, view, or use any included links to other documents, websites, or videos referenced to linked to from the PORTFOLIO. JUDGES may read additional information during pit interviews but will not bring back additional printed content to be referenced as part of the JUDGE deliberations.

Teams may use writing and research aids including Artificial Intelligence (AI) to help them compose their PORTFOLIOS. If AI or other resources are used, they must be credited via footnote or endnote, and respect intellectual property rights and licenses. Proper Credit can look like this: "PORTFOLIO created by Team XXXXX and ChatGPT".

A team may reference previous seasons (for example, in a team or organizational plan) to demonstrate growth, but the emphasis must be on the current season.

- A202** ***PORTFOLIOS must be submitted on time and as requested.** Teams must submit their PORTFOLIO as instructed by the Event Director and by the stated deadline if they wish to have it considered during the judging process. If no other instructions are provided, teams should submit 1 printed copy of their PORTFOLIO during the structured interview.

Instructions about when and how teams should submit their PORTFOLIOS should be communicated by the Event Director before the event.

If circumstances prevent a team from following the PORTFOLIO submission instructions, the Event Director should work with the JUDGE Advisor to make reasonable accommodations to accept all team PORTFOLIOS unless doing so poses an undue burden to the judging process.

- A203** ***Teams must attend a structured interview session.** To be considered for any judged awards the team must attend their assigned structured interview session.

Teams should be informed of their assigned time by the Event Director or local Program Delivery Partner in advance of the event. If there is a schedule conflict or the team misses their structured interview slot due to unforeseen circumstances the team should work with the Event Director or local Program Delivery Partner to make reasonable alternate accommodations for a structured interview at the event if possible.

- A204** ***Bring the right resources with you for your structured interview.** Teams attending their structured interview time slot should come prepared with the following:

- A. no less than 2 STUDENT representatives for teams of 2 STUDENTS and larger,
- B. a printed copy of their team PORTFOLIO (optional, submit as instructed by the Event Director),
- C. "show and tell" demonstration items which may include the team's ROBOT (encouraged, but optional),
- D. 1 silent observer per [A208](#) (optional), and

E. 1 support person to fill accommodation needs per [A209](#) (optional, as needed).

Teams are encouraged to have as many STUDENTS as possible involved in the structured interview process.

A team does not have to have a ROBOT to participate in judging or be eligible for judged awards.

Teams may power on and demonstrate their ROBOT functions during the structured interview unless explicitly disallowed by the Event Director or Local Program Delivery Partner. All teams should have the same demonstration restrictions.

A205 *Everyone gets equal structured interview time. All teams will be scheduled for the same length structured interview of at least 10 minutes with a minimum of 10 minutes reserved between structured interviews for JUDGES to confer.

A206 *The structured interview timer starts when the team starts. The timer starts after the team has entered the room and when they begin their presentation. Teams who take an extended amount of time to begin will be warned by the JUDGES to begin promptly and then the structured interview timer will be started regardless of the readiness of the presenting team.

Teams should enter the room and prepare to begin speaking in an expedited manner. This rule is aimed at letting large teams get lined up and oriented in the room and for the JUDGES to introduce themselves and provide reminders of the interview format.

Do not attempt to abuse the delayed start timer to set up equipment or otherwise gain an advantage.

A207 *Prepared structured presentation time should not be interrupted. The first 5 minutes of the structured interview are reserved for the team to present a prepared oral presentation uninterrupted, if they choose. The uninterrupted presentation time may be ended early by the team. Any remaining time should be a question and answer conversation with the STUDENTS and led by the JUDGES.

A208 *One adult silent observer is welcome. One adult mentor may attend the judging session and be present for any interaction between the JUDGES and the STUDENT team members. Adult mentor(s) may be present for any interactions between the JUDGES and the STUDENT team members outside of the structured interview. The adult observer and mentor(s) may not interact or actively coach during any interaction between the JUDGES and the STUDENT team members.

The purpose of the adult silent observer is to provide silent confidence to the STUDENT team members presenting in an unknown environment with new people.

A209 *Translator and/or Sign Language Interpreter accommodations will be made for teams who need it. Teams who need to use a translator to communicate with the JUDGES may provide one if the team's native language does not match that of the event host site provided JUDGES. This includes sign language or other adaptive technology. Teams who intend to interview with the assistance of a translator must work with the Event Director in advance to request additional interview time of between

2 and 5 minutes, if needed. The translator may be an adult and can be in addition to the silent observer in [A208](#).

In most cases the translator will need to be provided by the team. If other accommodation is needed, the team should [contact your local leadership](#) to discuss options.

A210 *No Photos, Video or Audio recording during structured interview. In addition to the restrictions of [E117](#), no recording of video or audio, or photos may be taken during the structured interview.

A211 *The number of awards given scales with event size. The total number of awards given is based on the number of teams checked in at the event. Not all awards are given at every competition. Only the awards specified in Table 6-1 based on the event size are points-eligible for advancement.

Table 6-1: Total judged awards available based on all event participating teams

		Total Event Participating Teams			
Award		4-10 Teams	11-20 Teams	21-40 Teams	41-64 Teams
Inspire Award		1 st Place	1 st Place 2 nd Place	1 st Place 2 nd Place 3 rd Place	1 st Place 2 nd Place 3 rd Place
Think Award		1 st Place	1 st Place	1 st Place 2 nd Place	1 st Place 2 nd Place (3 rd Place*)
TA Awards	Connect Award	1 st Place (Only one of Connect, Reach, or Sustain will be given)	1 st Place	1 st Place (2 nd Place*)	1 st Place 2 nd Place (3 rd Place*)
	Reach Award		1 st Place	1 st Place (2 nd Place*)	1 st Place 2 nd Place (3 rd Place*)
	Sustain Award		1 st Place	1 st Place (2 nd Place*)	1 st Place 2 nd Place (3 rd Place*)
MCI Awards	Design Award	1 st Place (Only one of Innovate, Control or Design will be given)	1 st Place	1 st Place (2 nd Place*)	1 st Place 2 nd Place (3 rd Place*)
	Innovate Award		1 st Place	1 st Place (2 nd Place*)	1 st Place 2 nd Place (3 rd Place*)
	Control Award		1 st Place	1 st Place (2 nd Place*)	1 st Place 2 nd Place (3 rd Place*)
Judges' Choice Award		Optional*	Optional*	Optional*	Optional*

*Discretionary awards

Check the [Judge and Judge Advisor Manuals](#) for exact details.

See section [13.8 Dual Division Events](#) for the modified dual division version of this rule.

A212 *Judging feedback is provided to all teams. All teams will receive feedback from their structured interview session. The JUDGES complete a form immediately following the structured interview based on their initial impression of the team. This feedback form is not used during deliberations and does not include any updated feedback based on later interactions by the JUDGES with the team.

The feedback form will either be returned with the PORTFOLIO for in-person judging near the end of the event, or the Lead Coach 1 will receive access to a digital version in [FTC-Scoring](#) following the event in the case of remote judging.

A213 *Teams are only eligible to win the Inspire Award in their own region. Teams are only eligible to be considered for the Inspire Award (1st, 2nd or 3rd place) when competing at a tournament within their own region.

A214 *Teams cannot win the Inspire Award at multiple Qualifying or League Tournaments. Teams are only eligible to win 1st place Inspire Award once per season from any Qualifying or League Tournament.

Teams who have won 1st Place Inspire are eligible to win 2nd or 3rd place Inspire Award at subsequent Qualifying or League Tournaments.

A215 *Teams can only get one judged award. Teams are only eligible to win or be a runner-up for a single judged award at the event.

6.3 Team Judged Award Descriptions

6.3.1 Inspire Award

The team that receives this award is a strong ambassador for *FIRST* programs and a role model *FIRST* team. This team is a top contender for many other judged awards and is a gracious competitor.

The Inspire Award winner is an inspiration to other teams, acting with Gracious Professionalism® both on and off the playing FIELD. This team shares their experiences, enthusiasm, and knowledge with other teams, sponsors, their community, and the JUDGES. Working as a unit, this team will have shown success in performing the task of designing and building a ROBOT.

Table 6-2: Inspire Award Criteria

Inspire Award Criteria		
Required	1	Team must submit a PORTFOLIO.
Required	2	The Inspire Award celebrates the strongest qualities of all the judged awards. A team must be a strong contender for at least one award in each of the following judged award categories: A. Machine, Creativity, and Innovation Awards, B. Team Attributes Awards, and C. Think Award.

Inspire Award Criteria

Required	3	Team must be positive and inclusive, and each team member contribute to the success of the team.
Required	4	Team is able to describe, demonstrate, document, or display their experiences and knowledge to the JUDGES.

6.3.2 Think Award

This judged award is given to the team that best reflects the journey the team took as they experienced their season. The content within the PORTFOLIO is the key reference for JUDGES to help identify the most deserving team. The team could share or provide additional detailed information that is helpful for the JUDGES.

Table 6-3: Think Award Criteria

Think Award Criteria		
Required	1	Team must submit a PORTFOLIO. The PORTFOLIO must include engineering content which includes at least one of the following: <ul style="list-style-type: none"> A. evidence of use of the engineering process, B. lessons learned and implemented related to the design of their ROBOT, C. trade off analysis /cost benefit analysis, and/or D. mathematical analysis used to make design decisions.
Encouraged	2	Team PORTFOLIO may include information about resources which includes any number of the following examples: <ul style="list-style-type: none"> A. how the team learns from team mentors, and/or a development plan for team members to learn new skills, B. how the team recruited new people into <i>FIRST</i>, and/or C. how the team identified goals and tracked progress towards their goals throughout the season.
Encouraged	3	PORTFOLIO information is organized in a clear and intuitive manner

6.3.3 Connect Award

This judged award is given to the team that connects with their local science, technology, engineering, and math (STEM) community to learn and adopt new tools through effort and persistence. This team has a team plan and has identified steps to achieve their goals. A PORTFOLIO is not required for this award.

Table 6-4: Connect Award Criteria

Connect Award Criteria		
Required	1	Team must describe, display, or document a team plan that covers all of the following: <ul style="list-style-type: none"> A. The team’s goals for the development of team member skills, and B. The steps the team has taken or will take to reach those goals
Encouraged	2	Provide examples of developing in person or virtual connections with individuals in the engineering, science, or technology community.
Encouraged	3	Provide examples of how it actively engages with the engineering community.

6.3.4 Reach Award

This award celebrates a team that has introduced and recruited new people into *FIRST*. Through their efforts, they have sparked others to embrace the *FIRST* culture. A PORTFOLIO is not required for this award.

Table 6-5 Reach Award Criteria

Reach Award Criteria		
Required	1	Team must discuss, describe, display, or document their outreach objectives and how their outreach activities support the <i>FIRST</i> community.
Required	2	Team must discuss, describe, display, or document their successful recruitment of new teams, or coaches, or mentors and/or volunteers who are not otherwise active within the <i>FIRST</i> community.
Encouraged	3	Is an ambassador for <i>FIRST</i> programs in a way that makes <i>FIRST</i> loud.
Encouraged	4	Has a creative and evolving approach to outreach materials that market their team and <i>FIRST</i> .

6.3.5 Sustain Award

Sustainability and planning are essential for a *FIRST* team, because they ensure the program’s long-term success. This award celebrates the team that has considered their future team members and has worked to ensure that their team or program will continue to exist long after they have gone on to develop their careers. A PORTFOLIO is not required for this award.

Table 6-6 Sustain Award Criteria

Sustain Award Criteria		
Required	1	Team must discuss, describe, display, or document their plan(s) which includes at least one of the following: A. finances and financial sustainability plan, B. season project planning, and/or C. team sustainability plans and/or objectives.
Required	2	Team must discuss, describe, display or document how a team tracks their progress towards their plan(s) listed above.
Encouraged	3	Team has clear team roles for all members of the team and a process for developing leadership.
Encouraged	4	Team can discuss, describe, display, or document how they manage the team’s constraints and/or risks.

6.3.6 Innovate Award sponsored by RTX

The Innovate Award celebrates a team that thinks imaginatively and has the ingenuity, creativity, and inventiveness to make their designs come to life. This judged award is given to the team that has an innovative and creative ROBOT design solution to any specific components in the FIRST Tech Challenge game. Elements of this award include design, robustness, and creative thinking related to design. This award may address the design of the whole ROBOT or of a MECHANISM attached to the ROBOT and should work consistently during MATCHES, but does not have to work all the time to be considered for this award. A PORTFOLIO is not required for this award.

Table 6-7: Innovate Award Criteria

Innovate Award Criteria		
Required	1	Team must describe, display, or document examples of the team’s engineering content that illustrate how the team arrived at their design solution.
Required	2	ROBOT or ROBOT MECHANISM is creative and/or unique in its design.
Required	3	The innovative element must be stable, robust, and contribute positively to the team’s game objectives most of the time.
Encouraged	4	Designs often come with risks, the team should discuss, describe, display or document how they mitigated that risk.

6.3.7 Control Award

The Control Award celebrates a team that uses sensors and software to increase the ROBOT’S functionality during gameplay. This award is given to the team that demonstrates innovative thinking and solutions to solve game challenges such as autonomous operation, improving mechanical systems with intelligent control, or using sensors to achieve better results. The solution(s) should work consistently during MATCHES but does not have to work all the time. Solutions considered for this award are not solely limited to the AUTO period of the MATCH and may also be used during TELEOP. The team’s PORTFOLIO must contain a summary of the software, sensors, and mechanical control but would not include copies of the code itself.

Table 6-8: Control Award Criteria

Control Award Criteria		
Required	1	Team must submit a PORTFOLIO. The PORTFOLIO must include all of the following: A. hardware and/or software control COMPONENTS on the ROBOT, B. which challenges each COMPONENT or system is intended to solve, and C. how does each COMPONENT or system work.
Required	2	Team must use one or more hardware or software solutions to improve ROBOT functionality by using external feedback and control.
Encouraged	3	The control solution(s) should work consistently during most MATCHES.
Encouraged	4	Team could discuss, describe, display, or document how the solution may consider reliability either through demonstrated effectiveness or identification of how the solution could be improved
Encouraged	5	Use of the engineering process to develop the control solutions (sensors, hardware and/or algorithms) used on the ROBOT includes lessons learned.

6.3.8 Design Award

The Design Award celebrates the team that demonstrates an understanding of industrial design principles by striking a balance between form, function, and aesthetics while meeting the needs of this season’s challenge. The design process used should result in a ROBOT which is efficiently designed and effectively addresses the game challenge. A PORTFOLIO is not required for this award.

Table 6-9: Design Award Criteria

Design Award Criteria		
Required	1	A team must be able to describe or demonstrate how their ROBOT is elegant, efficient (simple/executable), and practical to maintain.
Required	2	The entire machine design, or the detailed process used to develop the design, is worthy of this recognition, and not just a single COMPONENT.
Encouraged	3	The ROBOT distinguishes itself from others by its aesthetic and functional design.
Encouraged	4	The basis for the design is well considered (that is inspiration, function, etc.).
Encouraged	5	Design is effective and consistent with the team’s game plan and/or strategy.

6.3.9 Judges’ Choice Award

This award is optional and not given at all FIRST Tech Challenge events.

During the competition, the judging panel may meet a team whose unique efforts, performance, or dynamics merit recognition, but does not fit into any of the other award categories. To recognize these unique teams, FIRST offers a Judges’ Choice Award.

6.4 Tournament ALLIANCE Awards

6.4.1 Winning Alliance Award

This award will be given to the winning ALLIANCE represented in the final MATCH of the Playoffs of a single-division Tournament or Championship event. If the event is a dual-division or multi-division event, there will be Winning Alliance Awards awarded to both the division playoff winners and the event finals playoff winner.

6.4.2 Finalist Alliance Award

This award will be given to the finalist ALLIANCE represented in the final MATCH of the Playoffs of a single-division Tournament or Championship event. If the event is a dual-division or multi-division event this will be awarded to the division playoff finalists and the event finals playoff finalist.

6.5 Individual Awards

6.5.1 FIRST Leadership Award

The STUDENTS who earn *FIRST* Leadership Award status as a semi-finalist, finalist or winner, are great examples of current STUDENT leaders who have led their teams and communities to increased awareness for *FIRST* and its mission, champion *FIRST* Core Values such as [Inclusion](#), and embody *Gracious Professionalism*®. It is the goal of *FIRST* that these individuals will continue, post-award, as great leaders, [STUDENT alumni](#), and advocates of *FIRST*.

Please visit the [FIRST Leadership Award Website](#) to see complete award submission details and to see past *FIRST* Tech Challenge winners.

For regions of the world that do not use grade levels such as this to identify years of schooling: This award is intended for STUDENTS who are two (2) to three (3) years away from entering college or university. STUDENTS that would be attending college or university in the next academic year are not eligible. Mentors will be asked for the year of graduation during the nomination process.

6.5.2 Compass Award

This is an optional award and is only offered at the Regional Championship tournament level of competition. All teams attending *FIRST* Championship will have an opportunity to submit for this award.

The Compass Award recognizes an adult coach or mentor who has given outstanding guidance and support to a team throughout the year and demonstrates to the team what it means to be a Gracious Professional. The winner of the Compass Award will be chosen from candidates nominated by *FIRST* Tech Challenge STUDENT team members, via a 40-60 second video submission. The video must highlight how their mentor has helped them become an inspirational team. The video should emphasize what sets the mentor apart.

Table 6-10: Compass Award Criteria

Compass Award Criteria		
Required	1	Team must be able to clearly articulate this mentor's contribution to the team and explain what sets this mentor apart.

Compass Award Criteria

<p>Required</p>	<p>2</p>	<p>Submission must be in video format and meet the following requirements:</p> <ul style="list-style-type: none"> A. submitted by the deadline established by the Event Director or local Program Delivery Partner instructions, B. be in one of the following formats: .mp4, .mov, .avi, or .wmv (no links to streaming services will be accepted), C. one video submission per team per event (videos can be updated or changed between events), D. all music must be used with permission from the copywrite owners and be indicated in the video credits, and E. videos cannot be longer than 60 seconds, including credits.
------------------------	----------	---

Teams are encouraged to review the [FIRST Branding and Style Guidelines](#) before creating their video.

6.6 Project-Based Global Awards

Project-based global awards are awards that are only judged and awarded once per season and are open to all registered FIRST Tech Challenge teams. Each award has its own independent requirements and deadlines. These awards do not contribute towards team advancement.

6.6.1 Digital Animation Award sponsored by Worcester Polytechnic Institute (WPI)

This award, sponsored by Worcester Polytechnic Institute (WPI), celebrates STEAM (Science, Technology, Engineering, Art, and Mathematics) and emphasizes the ability to tell a story through animation that integrates technological, social, and humanistic concepts.

The 2026 Digital Animation Award is offered to help encourage students to cultivate skills in design and creation of animation while telling a story about the impact of technology on society. This award is open to all FIRST Robotics Competition teams and FIRST Tech Challenge teams and is optional. More information can be found on the [Digital Animation Award webpage](#).

6.6.2 Safety Animation Award sponsored by UL Solutions

The 2025-26 theme for the Safety Animation Award, sponsored by UL Solutions, is: Unearth Safety! For this animation teams are invited to dig deep to uncover impactful ways to implement safe and sustainable practices. Use bold storytelling and imaginative artistry to create a memorable message that inspires responsible exploration and careful stewardship of our resources. More information can be found on the [Safety webpage](#).

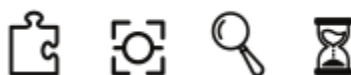

7 Game Sponsor Recognition

Thank you to the 2025-26 FIRST® Tech Challenge season presenting sponsor, RTX.

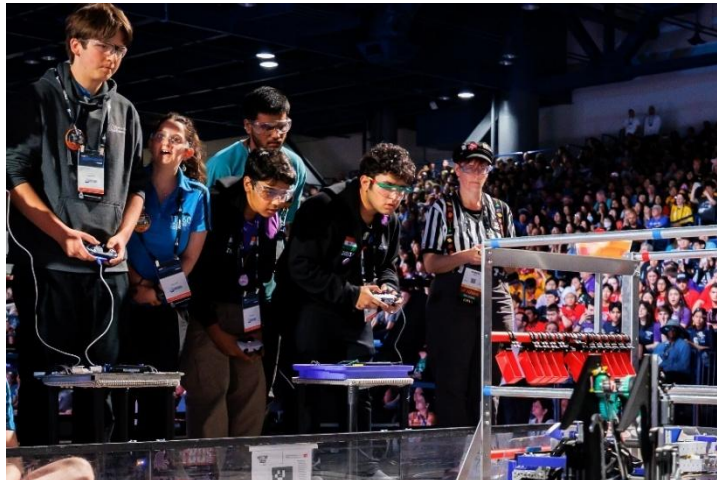

8 Game Overview

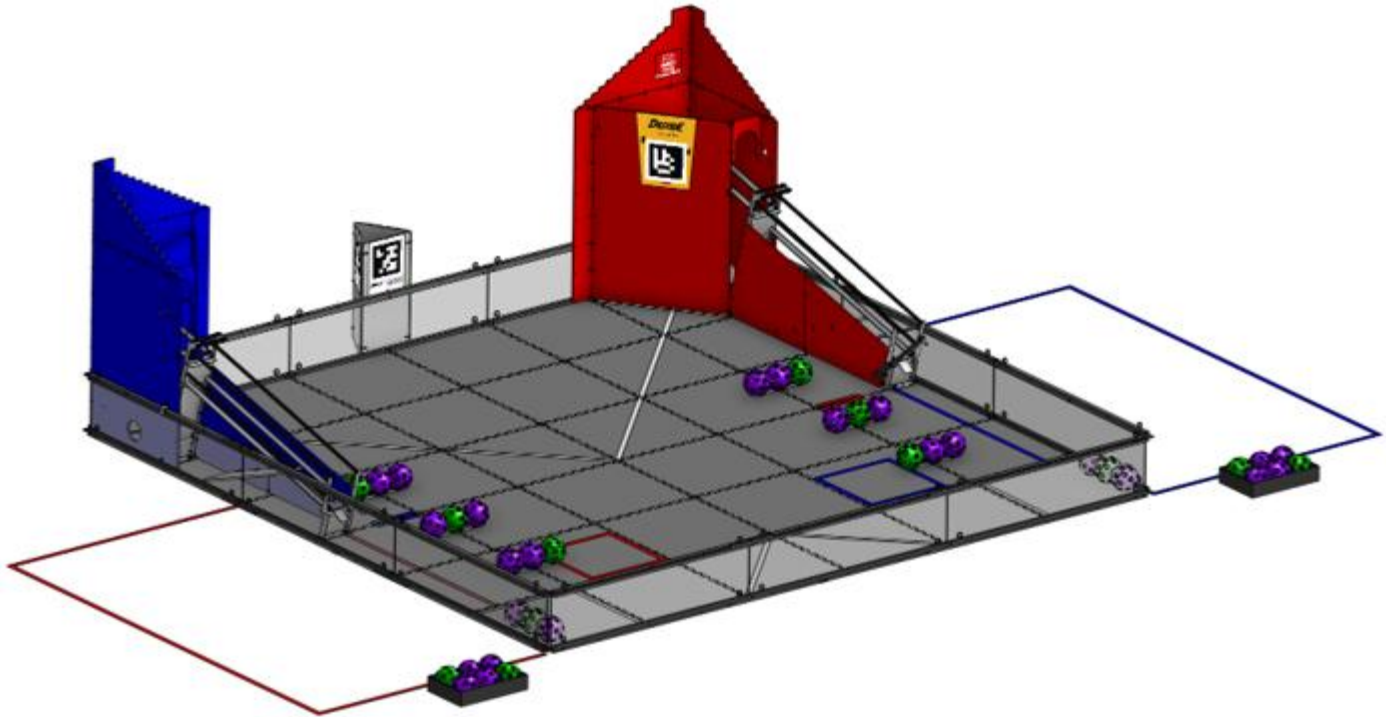

In DECODE™ presented by RTX 2 competing ALLIANCES of 2 teams each score purple and green ARTIFACTS in their GOAL, build PATTERNS, and race back to their BASE before time runs out.

Just before the match starts, the OBELISK is randomized to show one of 3 MOTIFS. The MOTIF for the MATCH defines what color PATTERN robots try to create on their RAMPS.

During the first 30 seconds of the MATCH, the ROBOTS operate autonomously. ROBOTS can use sensors to decode the randomized MATCH MOTIF. ROBOTS can earn points by scoring ARTIFACTS in their GOAL and building a PATTERN on their RAMP based on the MOTIF. ROBOTS also earn points for moving off the LAUNCH LINE.

During the remaining 2 minutes of the MATCH, human DRIVERS take control of their ROBOT. ROBOTS collect and continue to score ARTIFACTS in their GOAL to earn points. DRIVE TEAM members can retrieve ARTIFACTS from the ALLIANCE'S LOADING ZONE and help their ROBOTS by loading them with ARTIFACTS.

As time runs out, ALLIANCES can work together to return both of their ROBOTS to the BASE. ALLIANCES that build PATTERNS based on the MOTIF at the end of the MATCH earn additional points.

The ALLIANCE that earns the most points wins the MATCH and additional RANKING POINTS can be earned though completing other scoring achievements.

9 ARENA

The ARENA includes all elements of the game infrastructure that are required to play DECODE: the FIELD, SCORING ELEMENTS, queue area, team media area, and all equipment needed for event management.

Figure 9-1 DECODE (queue area, FIELD display, and optional media area not pictured)

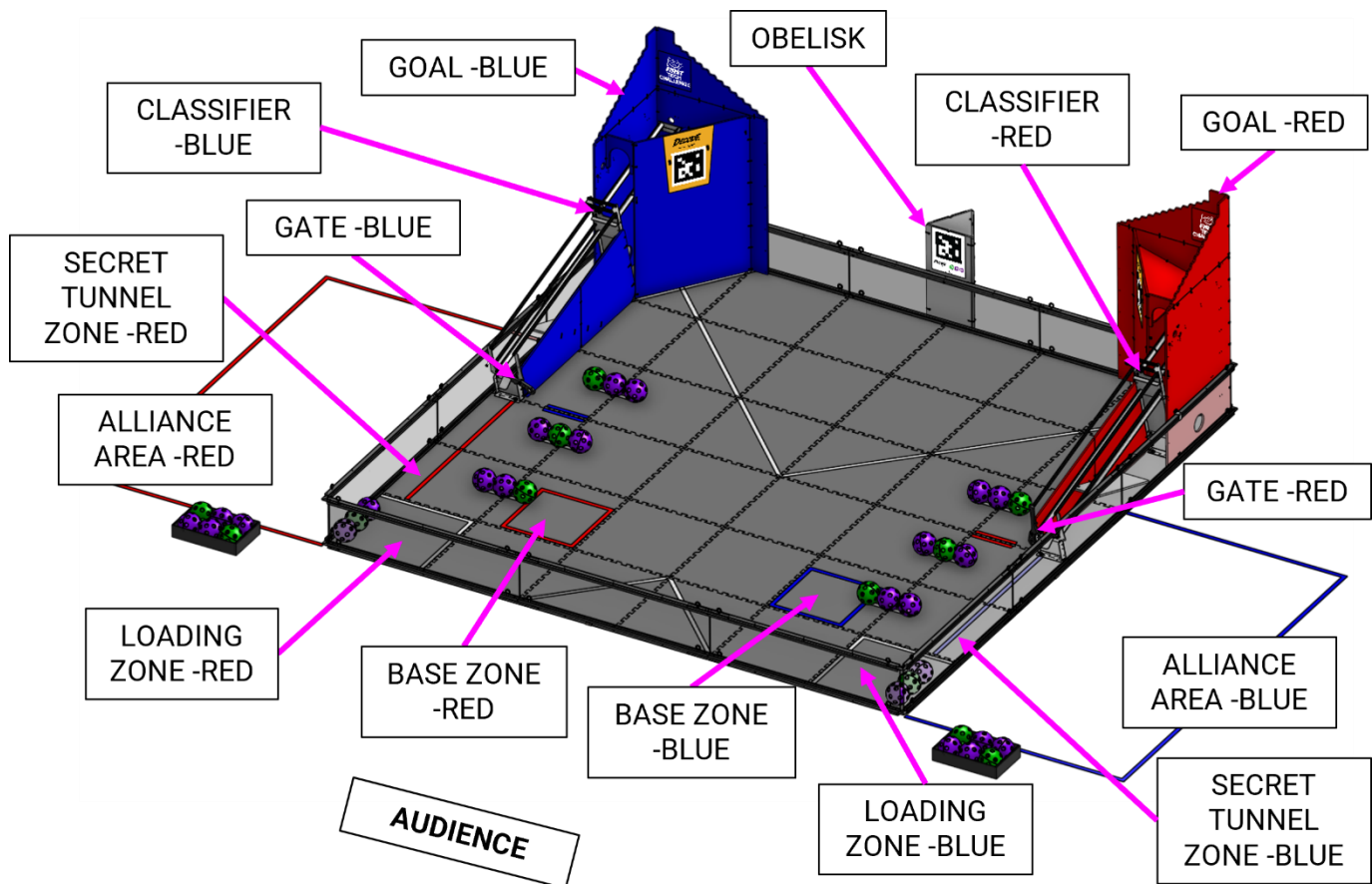

9.1 Dimensions and Accuracy

The specifications for the DECODE FIELD can be retrieved from a few locations:

- The 3D CAD model is the official representation of the DECODE FIELD and how it is constructed. Measurements may be taken from this model with a general tolerance of +/- 1 in. (+/- 2.5 cm).
- Illustrations included in the Competition Manual are for a general visual understanding of the DECODE ARENA, and any dimensions included are nominal. Unless specifically noted, all these dimensions carry a tolerance of +/- 1 in. (+/- 2.5 cm).
- The [Event FIELD Setup Guide](#) includes instructions on how to build the FIELD, and along with showing the ways construction type will influence the field tolerances, it also includes many of the key dimensions which are listed in the Official FIELD Drawings.
- The [FIELD Acceptance Checklist](#) includes the controlled dimensions (with relevant tolerances) which will be regularly inspected by event staff.

- The [FIELD Mitigation Guide](#) provides FIELD STAFF recommended mitigation measures for issues with the field during an event.

The complete list of DECODE FIELD resources are posted on the [Playing FIELD Resources page](#) on the *FIRST* website.

The ARENA is modular and is assembled, used, disassembled, and transported many times during the competition season. It undergoes wear and tear. The ARENA is designed to withstand rigorous play and frequent reassembly. Every effort is made to ensure that ARENAS are consistent from event to event.

However, ARENAS are assembled in different venues by different event staff and volunteers, and some small variations occur. In addition, every region faces unique challenges which may impact the exact implementation of the ARENA, and as such the ARENA specifications are designed to accurately reflect the variations which may be present in official play, while still ensuring consistency of critical items. Contact your [local support](#) to request more information.

Successful teams will design ROBOTS that are insensitive to these variations.

9.2 FIELD

Each FIELD for DECODE is an approximately 144 in. by 144 in. (365.75 cm by 365.75 cm) area bounded by the inside surface of the walls of the FIELD perimeter. The flooring surface of the FIELD is made of 36 interlocking soft foam TILES which are each approximately 24 in. by 24 in. by 0.59 in. (60.95 cm by 60.95 cm by 1.50 cm) nominally sized.

The FIELD is populated with and surrounded by the following FIELD elements:

- 1 CLASSIFIER per ALLIANCE which consists of a SQUARE, a RAMP, and a GATE
- 1 GOAL per ALLIANCE
- 1 OBELISK

Official events use the full DECODE FIELD manufactured and sold by AndyMark (am-5400_Full) or officially licensed equivalent.

The surface of the FIELD is [FIRST Tech Challenge Field Soft Tiles](#) (am-2499) or equivalent.

The primary version of the FIELD perimeter is the [FIRST Tech Challenge Perimeter Kit](#) (am-0481) sold by AndyMark. All illustrations in this manual show the am-0481 version of the FIELD design. Other versions of the FIELD perimeter of similar functionality may also be used in competitions.

Some events including the *FIRST* Championship (see section [15.2 Game Modification](#)) will place the FIELDS on platforms or risers such that the FIELD is raised while the ALLIANCE AREAS remain at ground level.

The FIELD variant used at an event will be determined by the local Program Delivery Partner and all competition FIELDS at the same event must comply with Section [9.1 Dimensions and Accuracy](#) and be consistent with each other per [T204](#).

9.3 Areas, Zones, & Markings

FIELD areas, zones, and markings of consequence are described below. The term “zone” is used to identify spaces within the FIELD, while the term “area” is used to describe spaces outside of the FIELD. Unless otherwise specified, the tape used to mark lines and zones throughout the FIELD is 1 in. (2.50 cm) wide [3M™ Premium Matte Cloth \(Gaffers\) Tape \(GT1\)](#), [ProGaff® Premium Professional Grade Gaffer Tape](#), or comparable gaffers tape in red, electric blue, and white. Areas outside the FIELD may be marked with other types or widths of tape, depending on the event.

The tape used to mark lines and zones throughout the FIELD is shown as continuous strips in all official specifications. However, events do not need to install the tape as a continuous strip:

- After applying the tape, event staff may cut the tape at the tile seams so the TILES may be removed without replacing the tape.
- Events may also apply the tape in multiple segments with gaps at the tile junctions.

REFEREES are instructed to treat these line segments as a continuous line segment, ignoring gaps, when applying game rules.

Figure 9-2 ALLIANCE AREA, LAUNCH LINES, and LAUNCH ZONE

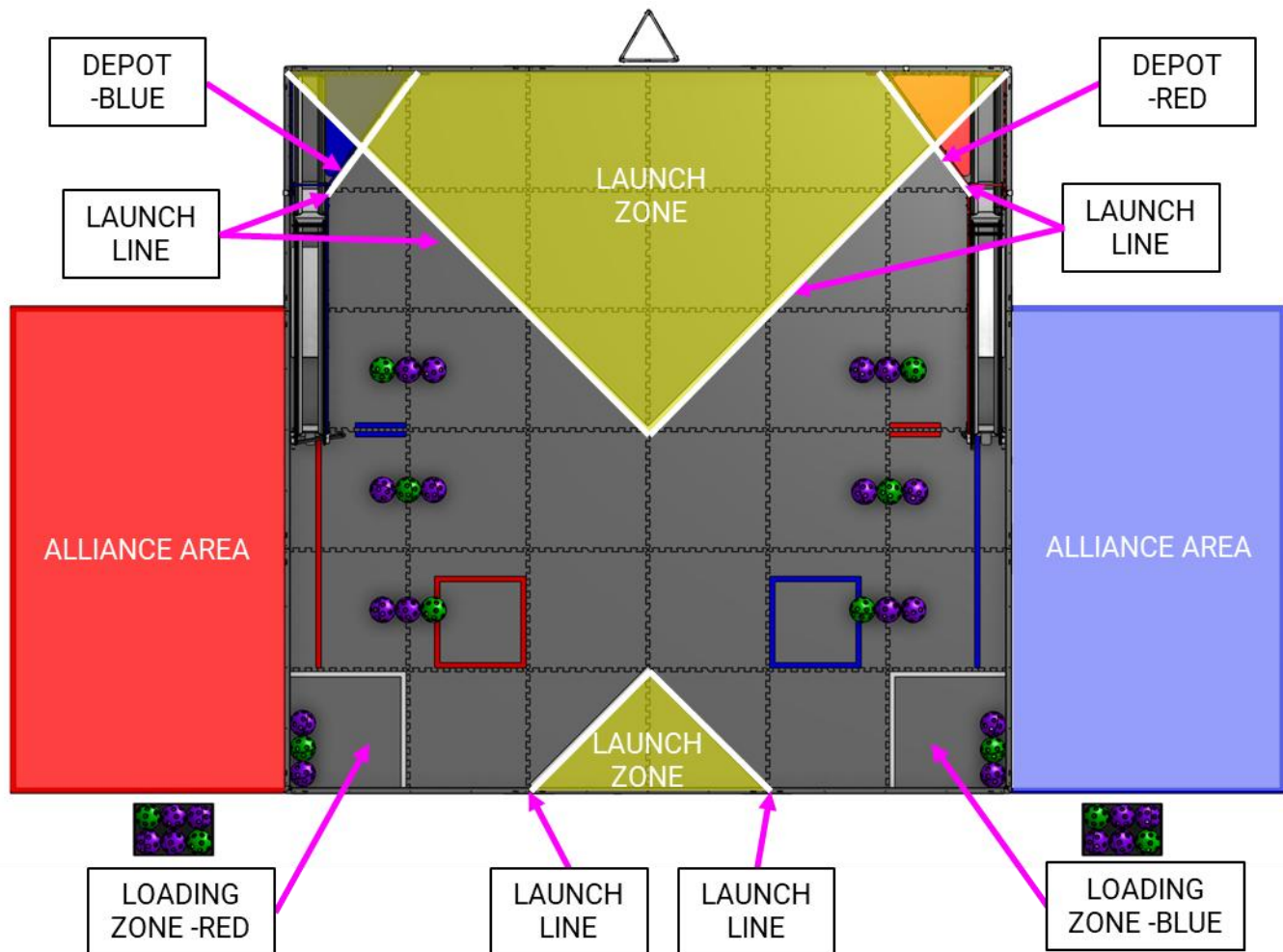

- ALLIANCE AREA: a 96 in. (243.85 cm) wide by 54 in. (137.15 cm) deep by infinitely tall volume formed by placing ALLIANCE colored tape onto the flooring surface outside of the FIELD. The ALLIANCE AREA includes the taped lines (Figure 9-2).
- DEPOT: the white tape approximately 30 in. (76.20 cm) long which spans the entire length of the GOAL front face and is located at the base of the GOAL. The DEPOT tape is a LAUNCH LINE (Figure 9-2).
- LAUNCH LINE: the white tape which bounds 2 triangular LAUNCH ZONES, as well as 2 segments of white tape located at the base of the GOAL.(Figure 9-2).
- LAUNCH ZONE: infinitely tall triangular volumes bounded by LAUNCH LINES and the FIELD perimeter. There are 2 LAUNCH ZONES: the LAUNCH ZONE on the audience side of the FIELD spans a section 2 TILES wide and 1 TILE deep and the LAUNCH ZONE on the GOAL side of the FIELD spans a section 6 TILES wide by 3 TILES deep. The LAUNCH ZONES include the tape that defines the LAUNCH LINES (Figure 9-2).

Figure 9-3: SECRET TUNNEL, GATE ZONE, LOADING ZONE, and SPIKE MARKS (shown with ARTIFACTS removed)

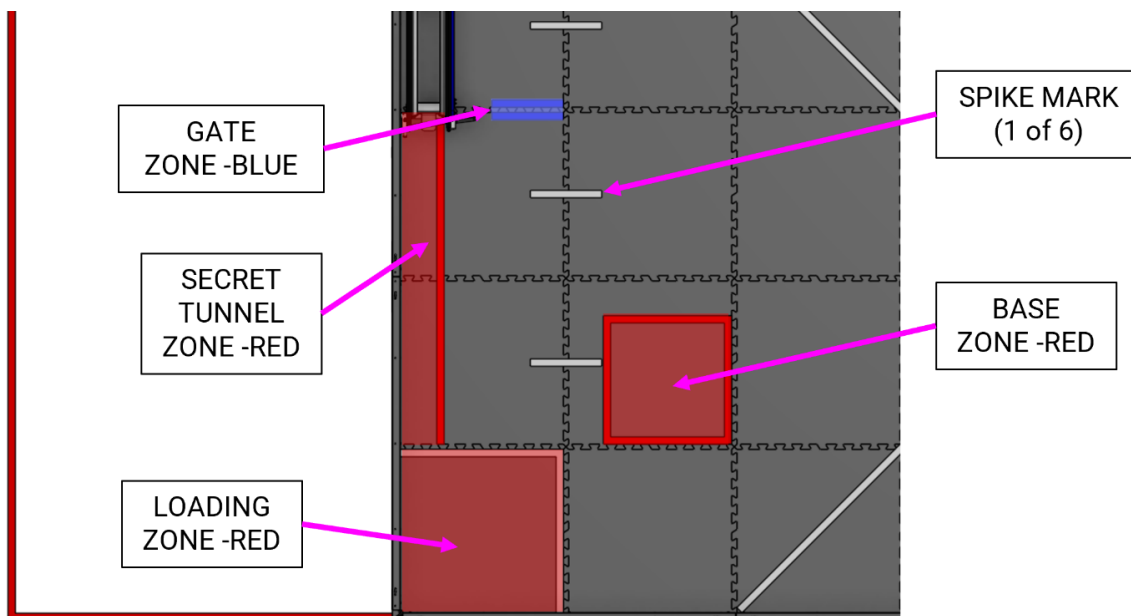

- BASE ZONE: an 18 in. +/- 0.125 in. (45.70 cm +/- 0.30 cm) wide by 18 in. +/- 0.125 in. (45.70 cm +/- 0.30 cm) deep infinitely tall volume bounded by ALLIANCE colored tape. The BASE ZONE is an ALLIANCE specific zone belonging to the matching color ALLIANCE. The BASE ZONE includes the tape lines (Figure 9-3).
- GATE ZONE: a 2.75 in. (7.00 cm) wide by 10 in. (25.40 cm) long infinitely tall volume bounded by 2 parallel 10 in. (25.40 cm) long ALLIANCE colored tape segments adjacent to each GATE. The GATE ZONE includes the tape lines (Figure 9-3).
- LOADING ZONE: an approximately 23 in. (58.40 cm) wide by 23 in. (58.40 cm) deep infinitely tall volume bounded by white tape and the adjoining FIELD perimeters. The LOADING ZONE includes the tape lines (Figure 9-3). The LOADING ZONE is an ALLIANCE specific zone belonging to the ALLIANCE with the adjacent ALLIANCE AREA.

- SECRET TUNNEL ZONE: an approximately 46.5 in. (118.10 cm) long by approximately 6.125 in. (15.55 cm) wide infinitely tall volume bounded by ALLIANCE colored tape, the GOAL assembly, the LOADING ZONE, and the adjoining FIELD perimeter. The SECRET TUNNEL ZONE includes the ALLIANCE colored tape lines and excludes the white tape (Figure 9-3). The SECRET TUNNEL ZONE is an ALLIANCE specific zone belonging to the matching color ALLIANCE.
- SPIKE MARK: 1 of 6 white tape marks 10 in. (25.40 cm) long used to identify the placement of 3 ARTIFACTS before the MATCH (Figure 9-3).

9.4 TILE Coordinates

TILE coordinates are used to assist with FIELD setup. Figure 9-4 defines the intersections of each of the TILES on the FIELD where the TILE tabs interlock. Figure 9-5 defines the grid coordinate system for each of the TILES.

Figure 9-4: TILE tab-line locations

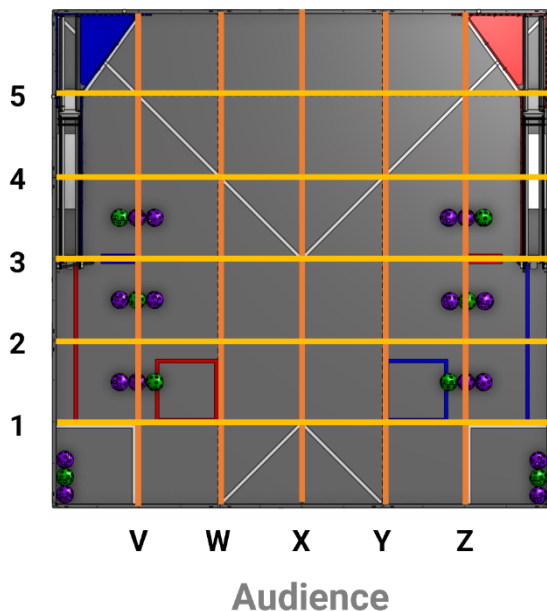
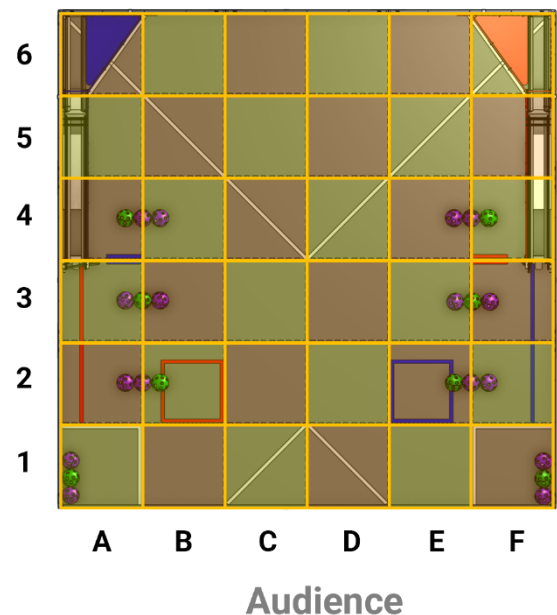

Figure 9-5: TILE locations



9.5 ALLIANCE AREA

An ALLIANCE AREA is the designated red or blue ALLIANCE AREA adjacent to the FIELD where the DRIVE TEAMS stage themselves during a MATCH. The FIELD is oriented such that the red ALLIANCE AREA is located on the left from the primary audience viewing direction.

Short tables, stands, or stools may be provided by the event which will sit near the FIELD perimeter inside the ALLIANCE AREA. These tables are provided for teams to place their OPERATOR CONSOLES. If provided by the event, these tables may not be removed or rearranged by the teams without permission from the Head REFEREE, FIELD Supervisor, or FTA.

Figure 9-6: ALLIANCE AREA

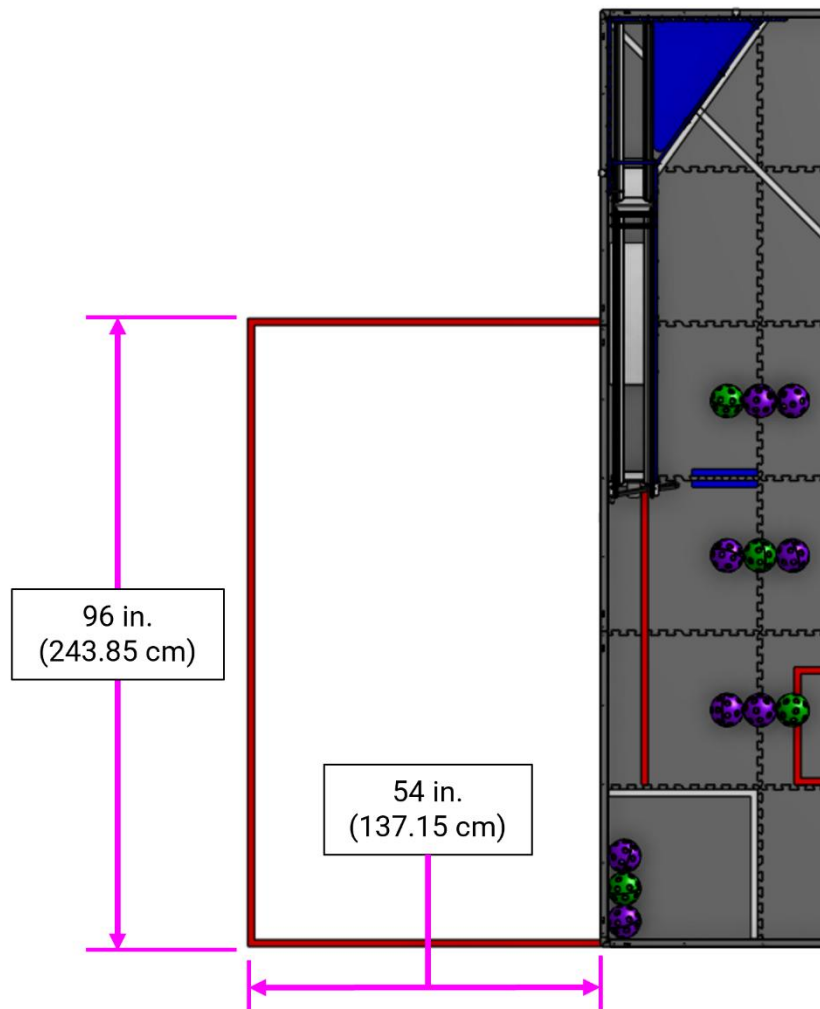

9.6 OBELISK

The OBELISK is an equilateral triangular prism (we know, real [obelisks](#) have 4 sides) which is positioned with 1 of the rectangular faces centered on the GOAL-side of the FIELD, just outside of the FIELD perimeter. The OBELISK is 23 in. (58.40 cm) tall and each rectangular face is 11 in. (27.95 cm) wide (Figure 9-7).

Figure 9-7: OBELISK dimensions

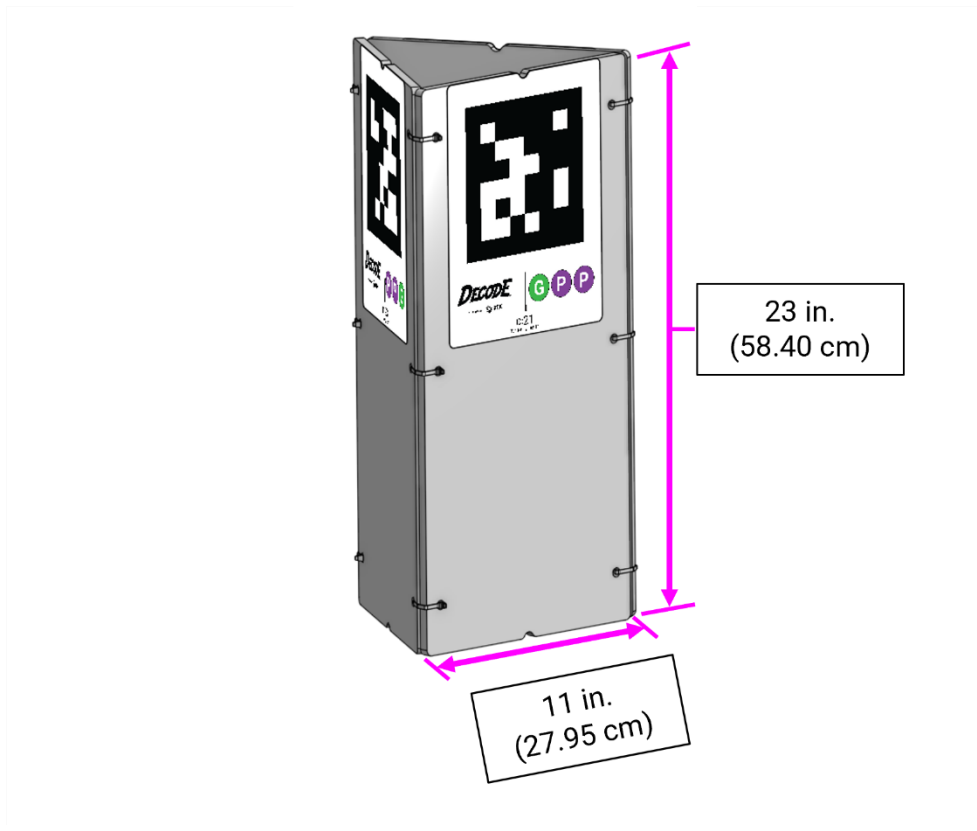

Each of the 3 rectangular faces of the OBELISK has an AprilTag (see section [9.10 AprilTags](#)) which corresponds to a different MOTIF. A MOTIF is a series of ARTIFACT colors, comprised of 2 purple (P) and 1 green (G), in a unique order. There are 3 MOTIFS in DECODE (GPP, PGP, PPG).

The OBELISK orientation is randomized by the FIELD STAFF using the event management software after DRIVE TEAMS have set-up for the MATCH ([G304](#)). The event management software will determine which face of the OBELISK should face towards the FIELD and the FIELD STAFF will put it in place. The location of the OBELISK will be approximately centered along the outside edge of the FIELD perimeter with the face containing the AprilTag approximately parallel to and contacting the FIELD perimeter wall.

The location of the OBELISK is not intended to be deterministic relative to the field coordinate system and should not be used for navigation.

9.7 GOAL

The GOAL is an approximately 27 in. (68.60 cm) by 27 in. (68.60 cm) by 54 in. (137.15 cm) tall structure primarily composed of 0.39 in. (1.00 cm) thick polypropylene corrugated plastic sheet. The GOAL is a 3-sided structure with a horizontal triangular shaped opening at the top. On the side where the CLASSIFIER connects to the GOAL there is an exit archway (Figure 9-8).

Figure 9-8: GOAL with Archway exit

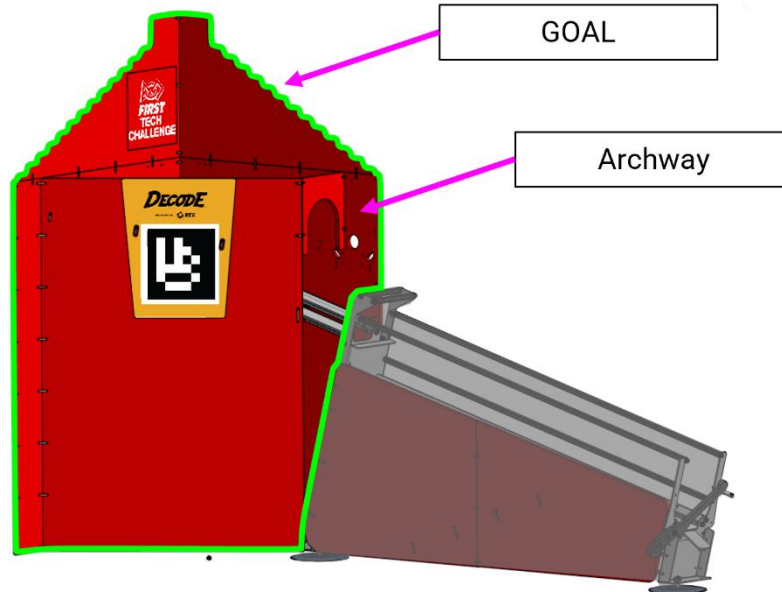

The opening of the GOAL is approximately 26.5 in. (67.30 cm) wide and 18.3 in. (46.45 cm) deep. The top lip of the GOAL is 38.75 in. (98.45 cm) from the surface of the TILE. The maximum height of the backboard with the *FIRST* Tech Challenge logo is 15 in. (38.10 cm) from the open top of the GOAL (Figure 9-9).

Figure 9-9: GOAL Dimensions

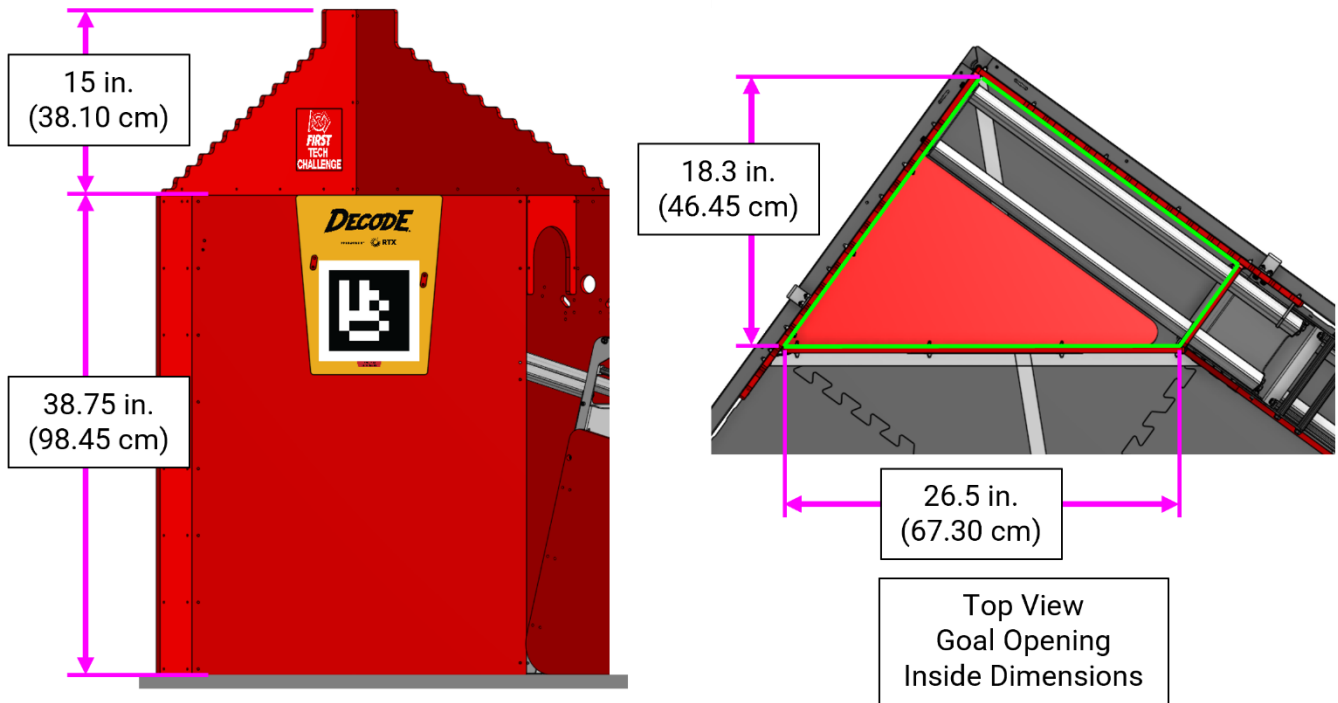

9.8 CLASSIFIER

The CLASSIFIER is a structure attached to the GOAL which has 3 main components: the SQUARE, RAMP, and GATE (Figure 9-10).

Figure 9-10: CLASSIFIER with no SCORING ELEMENTS

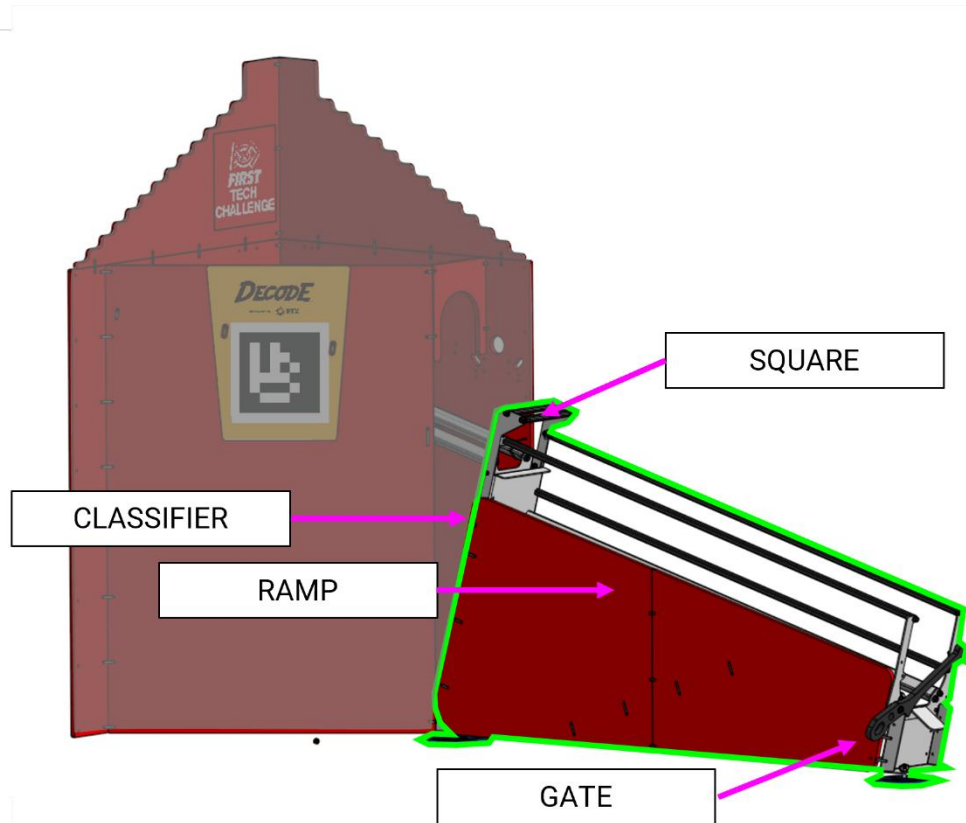

9.8.1 SQUARE

The SQUARE (Figure 9-11) is a location at the top of the RAMP at which ARTIFACT scoring is assessed as per [10.5 Scoring](#).

Figure 9-11: SQUARE on the RAMP

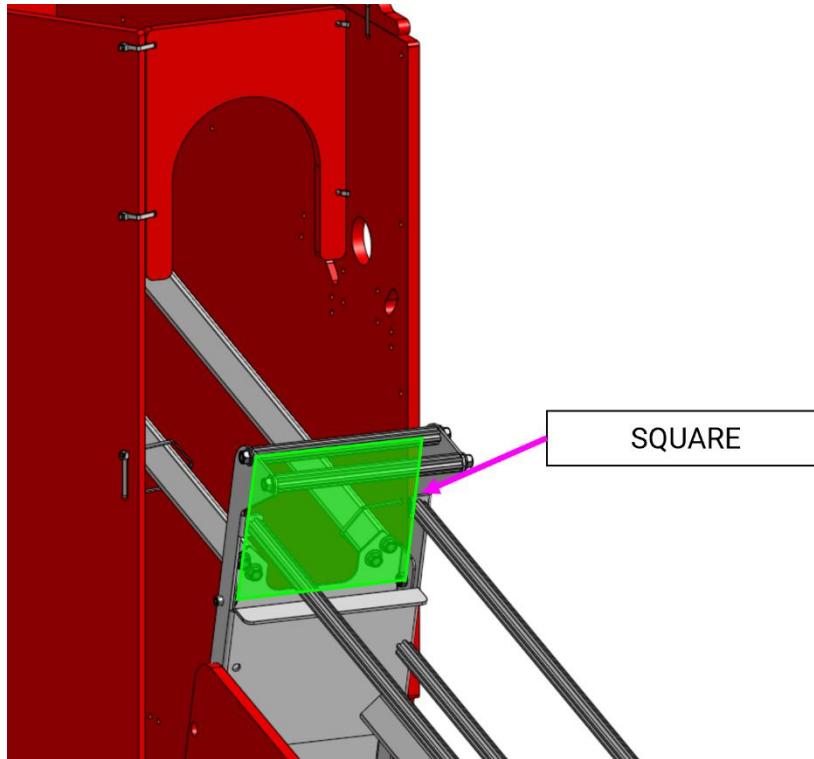

9.8.2 RAMP

The RAMP is a structure made of primarily aluminum extrusion. The RAMP can fit up to 9 CLASSIFIED ARTIFACTS before newly entered ARTIFACTS will OVERFLOW.

Figure 9-12: RAMP with no SCORING ELEMENTS

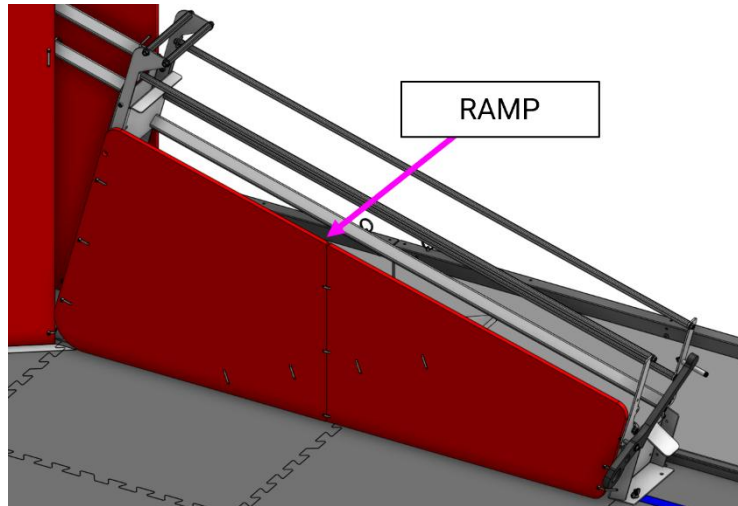

In most cases exactly 9 ARTIFACTS will fit on the RAMP as CLASSIFIED before newly entered ARTIFACTS will OVERFLOW, but sometimes ARTIFACTS LAUNCHED into the GOAL at a high velocity or with significant spin may skip over the 9th open CLASSIFIER slot and count as OVERFLOW. This is a normal FIELD operation and not an ARENA FAULT.

Figure 9-13: RAMP partially full of SCORING ELEMENTS

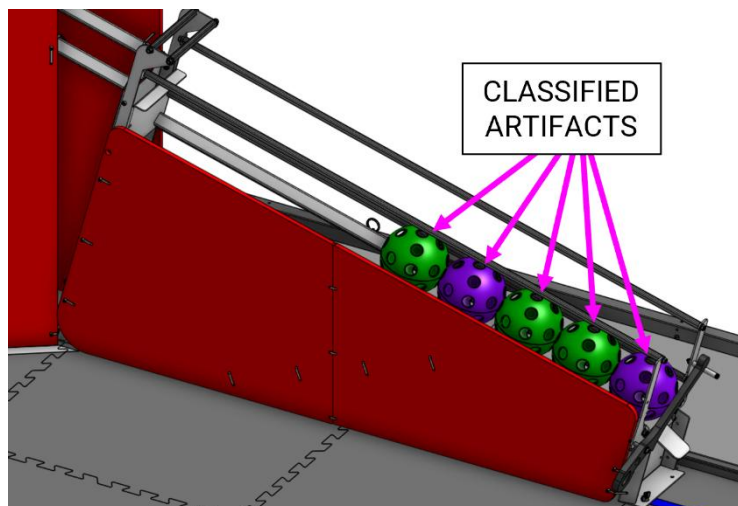
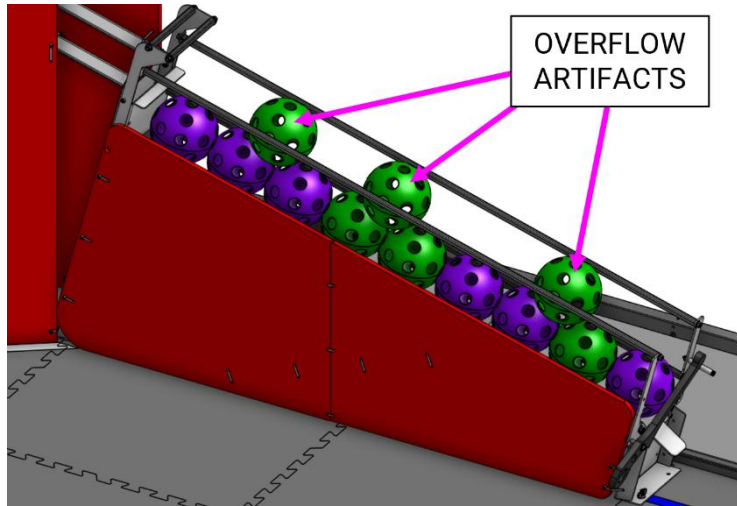

Figure 9-14: RAMP full of SCORING ELEMENTS with OVERFLOW



9.8.3 GATE

The GATE is an ALLIANCE specific FIELD element that prevents CLASSIFIED ARTIFACTS from exiting the RAMP into the opposing ALLIANCE'S SECRET TUNNEL ZONE (Figure 9-15). OVERFLOW ARTIFACTS can pass over the top of the GATE to exit the RAMP into the opposing ALLIANCE'S SECRET TUNNEL ZONE. The GATE is closed by gravity and after opening it may or may not stay open to clear all CLASSIFIED ARTIFACTS.

Figure 9-15: GATE

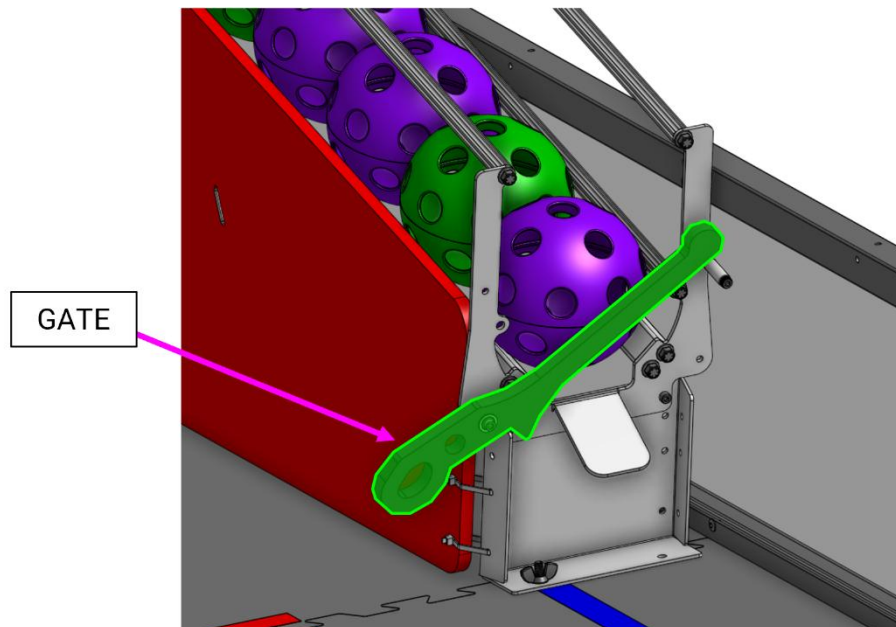

The GATE is a ROBOT-activated, push to open mechanism which will release ARTIFACTS which are CLASSIFIED on the RAMP (Figure 9-16).

The GATE will take variable amounts of time to close. The GATE closing before all CLASSIFIED ARTIFACTS exit the RAMP is not considered an ARENA FAULT, and teams should be prepared to hold the GATE open to fully clear the RAMP. The GATE not closing immediately when released by the ROBOT (but closing eventually) is not considered an ARENA FAULT. During a MATCH, FIELD STAFF may follow steps in the [Field Mitigation Guide](#) to mitigate some FIELD issues during a MATCH. Refer to the Field Mitigation Guide for more guidance on how FIELD STAFF will respond to inconsistent FIELD behavior.

When closed, the height of the contact area of the GATE above the surface of the TILE ranges from approximately 3.75 in. (9.55 cm) to 5.5 in. (14.00 cm) and when open the contact point is approximately 3 in. (7.60 cm) above the TILES (Figure 9-16). The total horizontal displacement required to move the GATE from closed to open is approximately 2 in. (5.10 cm).

TEAMS are encouraged to design their ROBOTS with a large vertical surface which ensures consistent contact with the GATE arm. It is particularly important that this panel extends up to the high end of the interface range approximately 5.5 in. (14.00 cm) above the TILE surface. This ensures the ROBOT cannot end

up “under” the GATE arm and will help prevent ROBOTS from inadvertently damaging the FIELD.

Figure 9-16: GATE Actuation: Open & Closed

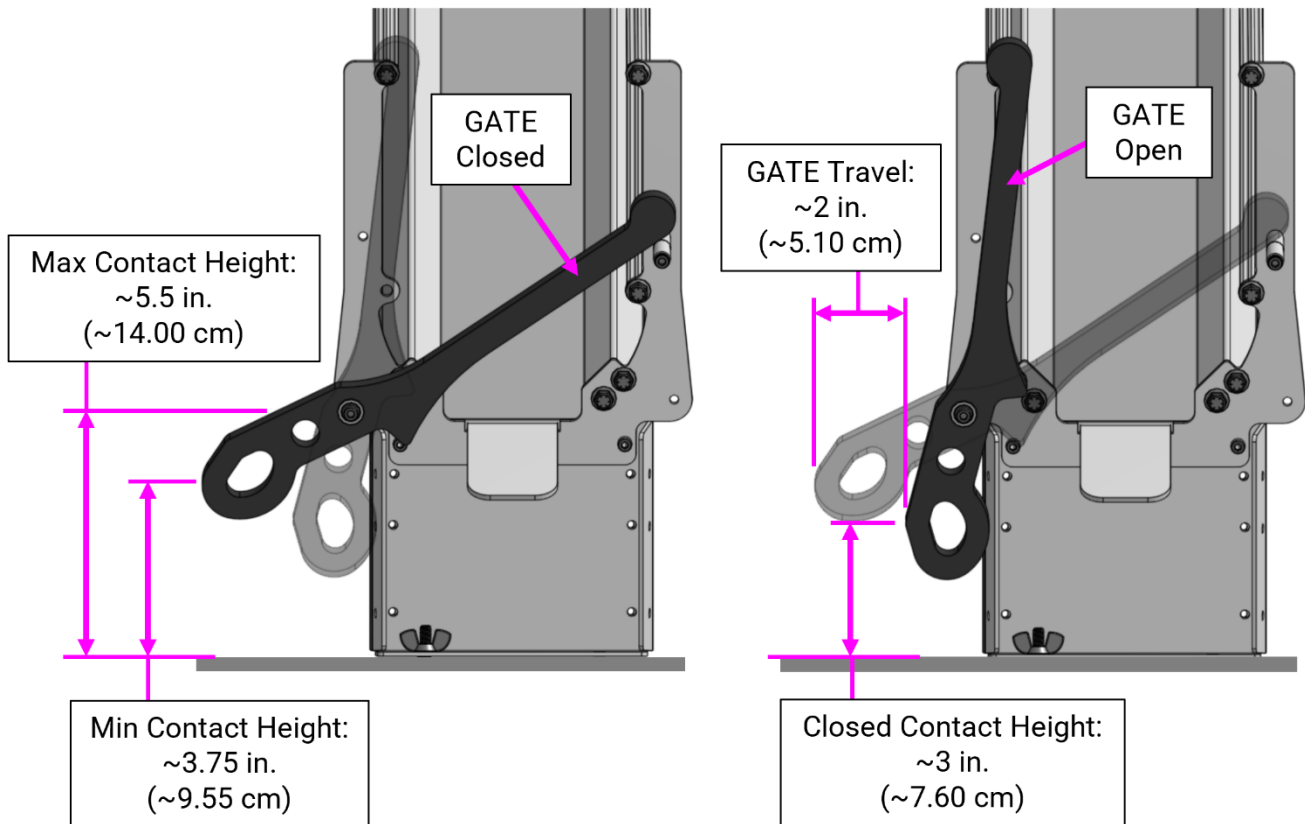

9.9 SCORING ELEMENTS

SCORING ELEMENTS are ALLIANCE neutral ARTIFACTS. ARTIFACTS are 5 in. (12.70 cm) nominal Gopher ResisDent™ polypropylene balls in purple ([am-3376a_purple](#)) and green ([am-3376a_green](#)). There are 24 purple (P) ARTIFACTS and 12 green (G) ARTIFACTS total in a DECODE MATCH.

ARTIFACTS are not perfectly spherical and may vary in size. Teams should plan for this variation when designing their ROBOTS. Based on the specifications provided by the manufacturer, ARTIFACTS are specified to be 4.9 in +/- 0.25 in. (12.45 cm +/- 0.65 cm) in diameter at the mold seam.

Figure 9-17: SCORING ELEMENTS (ARTIFACTS)



9.10 AprilTags

AprilTags for DECODE are 8.125 in. (~20.65 cm) square targets from the 36h11 tag family (Figure 9-18).

AprilTags are placed on the front face of the GOAL to help aid in ROBOT navigation and targeting. The red ALLIANCE GOAL has ID 24, and the blue ALLIANCE GOAL has tag ID 20. Each marker has an identifying “TAG ID” text label (Figure 9-19).

AprilTags with the ID 21, 22, 23 are located on each rectangular face of the OBELISK, which is placed outside of the FIELD and can be used to identify the MOTIF for the MATCH.

The OBELISK AprilTag is not recommended for ROBOT navigational use as the exact placement location may vary from MATCH to MATCH.

Figure 9-18: AprilTag Locations on the DECODE FIELD

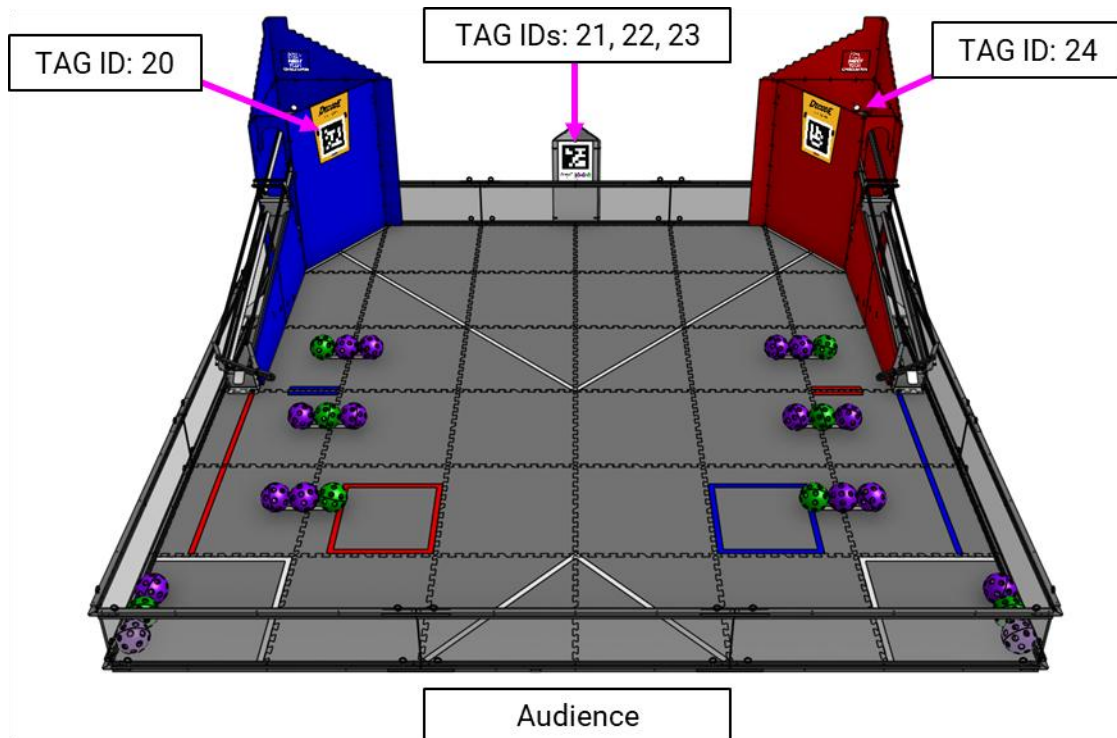
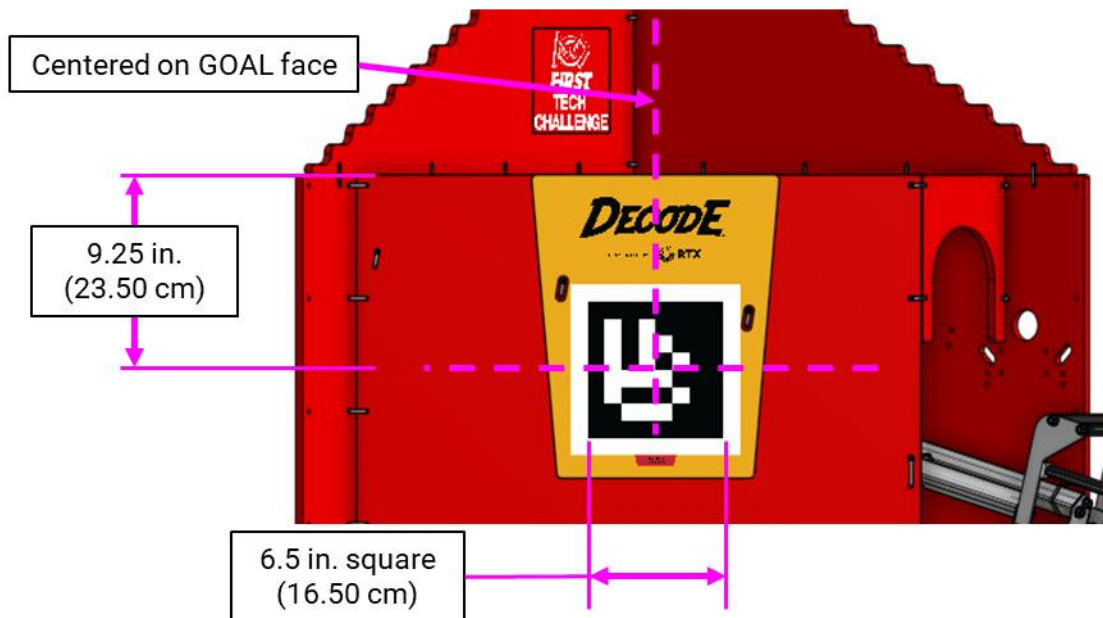

Figure 9-19: AprilTag location on the GOAL



Do not print the images from this manual for practice purposes, they are examples only and are not the same size as those used in the ARENA. Please refer to the [Playing Field Resources page](#) for printable versions of these images, including instructions on how to place the images correctly around the FIELD.

9.11 FIELD STAFF

FIELD STAFF are volunteers present in and around the ARENA that are responsible for making sure the MATCHES are cycled through efficiently, fairly, safely, and with a spirit of cooperation, *Gracious Professionalism*[®], and generosity of spirit. FIELD STAFF roles are filled by volunteers from the community who prepare for the event with thorough training and certification. There are 3 FIELD-side key volunteer roles with whom teams should be familiar with and are encouraged to use as resources to make their event experience valuable.

- Head REFEREE – trains, directs, and supervises REFEREES. They oversee all scoring processes and procedures in collaboration with other FIELD STAFF. They interact with STUDENTS, volunteers, and event staff. The Head REFEREE has final authority for decisions regarding MATCH scores, FOULS, and YELLOW and RED CARD assignments.
- *FIRST* Technical Advisor (FTA) - ensures events run smoothly, safely, and in accordance with *FIRST* requirements. The FTA collaborates with *FIRST* staff, event staff, and other event volunteers in many different areas at events. The FTA focuses on all technical things related to the FIELD, ROBOTS, and game, and acts as a team advocate for all teams competing at the event.
- FIELD Supervisor - (may be the same as the FTA or Head REFEREE at smaller events) directs activity on the FIELD to ensure efficient execution of the MATCHES, pacing of the event, and smooth flow of MATCH play. FIELD Supervisors are responsible for ensuring the FIELD is intact and lead FIELD reset teams, who are responsible for resetting the FIELD after each MATCH in preparation for the subsequent MATCH.

For additional details about each of these roles, as well as other *FIRST* Tech Challenge volunteer roles, please refer to our [volunteer resources](#).

9.12 Event Management System

The *FIRST* event management system is the software responsible for managing the MATCH scores and other event inputs. The system encompasses all FIELD electronics, including computers, displays, REFEREE and other volunteer electronic devices, wireless access point, ethernet cables, etc.

The *FIRST* event management system alerts participants to milestones in the MATCH using audio cues detailed in Table 9-1. Please note that audio cues are intended as a courtesy to participants and not intended as official MATCH markers. If there is a discrepancy between an audio cue and the visual FIELD timers, the visual FIELD timers are the authority.

Table 9-1 Audio cues

Event	Timer Value	Audio Cue
MATCH start	2:30	"Cavalry Charge"
AUTO ends	2:00	"Buzzer x 3"
AUTO to TELEOP Transition	0:07 to 0:01	"Drivers, pick up your controllers, 3-2-1"
TELEOP begins	2:00	"3 Bells"
Final 20 seconds	0:20	"Train Whistle"
MATCH end	0:00	"3-second Buzzer"
MATCH stopped	N/A	"Foghorn"

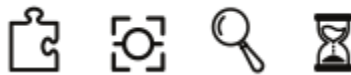

10 Game Details

Figure 10-1: FIELD for DECODE

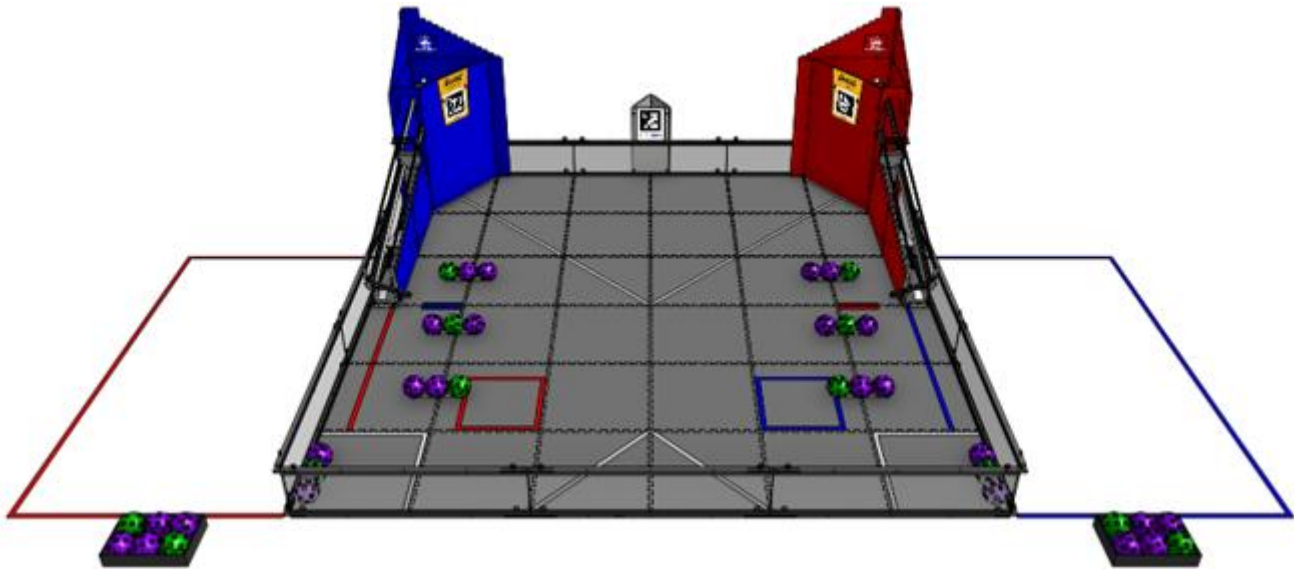

In DECODE, 2 ALLIANCES (an ALLIANCE is a cooperative of 2 FIRST Tech Challenge teams) play MATCHES, set up and implemented per the details described below.

10.1 MATCH Overview

MATCHES run on a typical 5- to 12-minute cycle time per FIELD, which consists of pre-MATCH setup, a 30-second AUTO period, an 8-second transition period between AUTO and TELEOP, and a 2-minute TELEOP period, followed by the post-MATCH reset.

During the MATCH, ROBOTS collect ARTIFACTS and score them into their GOAL to CLASSIFY and create the randomly selected MOTIF. ROBOTS can then open their GATE to continue CLASSIFYING additional ARTIFACTS. ARTIFACTS which do not drop into the RAMP will count as OVERFLOW.

ROBOTS conclude the MATCH by returning to their BASE.

10.2 DRIVE TEAM

A DRIVE TEAM is a set of up to 4 people from the same FIRST Tech Challenge team responsible for team performance for a specific MATCH. There are 3 specific roles on a DRIVE TEAM which ALLIANCES can use to assist ROBOTS, and no more than 1 member of the DRIVE TEAM is allowed to be a non-STUDENT.

The intent of the definition of DRIVE TEAM and DRIVE TEAM related rules is that, barring extenuating circumstances, the DRIVE TEAM consists of people who arrived at the event affiliated with that team and are responsible for their team's and ROBOT'S performance at the event (this means a person may be affiliated with more than 1 team).

The intent is not to allow teams to “adopt” members of other teams for strategic advantage for the loaning team, borrowing team, and/or their ALLIANCE (e.g., an ALLIANCE Lead believes 1 of their DRIVERS has more experience than a DRIVER of their ALLIANCE partner, and the teams agree the partner team will “adopt” that DRIVER and make them a member of their DRIVE TEAM for Playoffs).

The definition is not stricter for 2 main reasons. First, to avoid additional bureaucratic burden on teams and event volunteers (e.g., requiring that teams submit official rosters that Queuing must check before allowing a DRIVE TEAM into the ARENA). Second, to provide space for exceptional circumstances that give teams the opportunity to display *Gracious Professionalism* (e.g., a bus is delayed, a DRIVE COACH has no DRIVERS, and their pit neighbors agree to help by loaning DRIVERS as temporary members of the team until their bus arrives).

Table 10-1: DRIVE TEAM roles

Role	Description	Max./ DRIVE TEAM	Criteria
DRIVE COACH	a guide or advisor	1	any team member and may be an adult, must wear “DRIVE COACH” badge
DRIVER	an operator and controller of the ROBOT	3	STUDENT, must wear a “DRIVE TEAM” badge
HUMAN PLAYER	a SCORING ELEMENT manager		

A STUDENT is a person who has not completed high-school, secondary school, or the comparable level in their home region as of September 1st of the current season.

10.3 Setup

Before each MATCH begins, FIELD STAFF stage SCORING ELEMENTS as described in section [10.3.1 SCORING ELEMENTS](#) DRIVE TEAMS stage their ROBOTS (as described in section [10.3.4 ROBOTS](#)) and OPERATOR CONSOLES (as described in section [10.3.3 OPERATOR CONSOLES](#)). Then, DRIVE TEAMS take their places as described in section [10.3.2 DRIVE TEAMS](#)

10.3.1 SCORING ELEMENTS

Figure 10-2: SCORING ELEMENTS staging positions

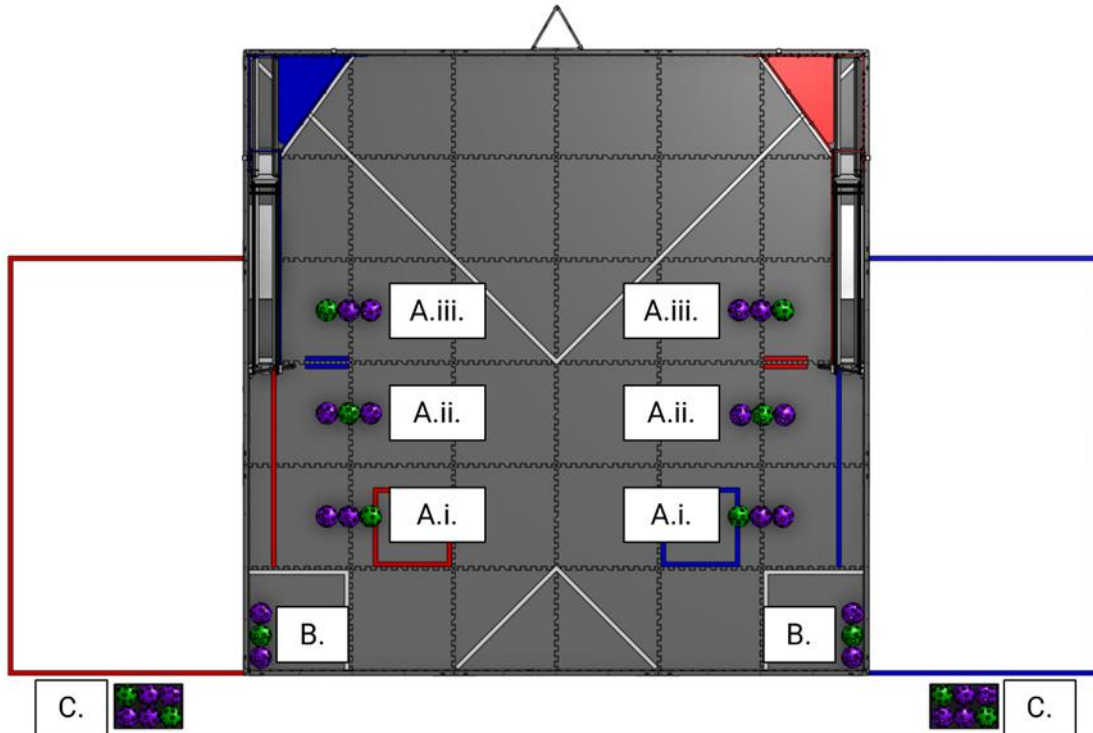

24 purple (P) and 12 green (G) ARTIFACTS and are staged on the FIELD as follows, with the MOTIFS starting from the middle of the FIELD and continuing toward the FIELD perimeter:

- A. 3 ARTIFACTS on each SPIKE MARK arranged as follows:
 - i. Near (audience side): GPP
 - ii. Middle: PGP
 - iii. Far (GOAL side): PPG
- B. 3 ARTIFACTS (2P, 1G) in each LOADING ZONE biased against the FIELD perimeter adjacent to the ALLIANCE AREA and closest to the corner arranged PGP.
- C. 6 ARTIFACTS (4P, 2G) in each ALLIANCE AREA (may be organized in provided ARTIFACT tray or similar container) with no set order

Each ROBOT may be pre-loaded with up to 3 ARTIFACTS from their own ALLIANCE AREA pre-staged ARTIFACTS in C such that each ARTIFACT is in direct contact with the ROBOT.

As described in [15.2 Game Modification](#), the number, type, and distribution of SCORING ELEMENTS may be adjusted for the *FIRST* Championship and *FIRST* Premier Events. For the *FIRST* Championship, any game modifications will be published on or before the last regularly scheduled Team Update as described in section [1.8 Team Updates](#). For *FIRST* Premier Events, game modifications will be posted by the event organizers prior to the event.

10.3.2 DRIVE TEAMS

DRIVE TEAMS prepare for a MATCH by staging in the ALLIANCE AREA after the DRIVE TEAM from the previous MATCH has left. DRIVE TEAM starting conditions are listed below, and a DRIVE TEAM obstructing or delaying any of the conditions is at risk of violating [G301](#).

- A. only DRIVE TEAM members assigned to the upcoming MATCH are present.
- B. only DRIVE TEAM members whose ROBOTS have passed initial, complete Inspection are present.
- C. DRIVE TEAM members are staged in their designated ALLIANCE AREA. If members of the ALLIANCE cannot agree where their DRIVE TEAM members will be staged, the team listed on the MATCH schedule as “Red 1” or “Blue 1” will stage closest to the audience.
- D. DRIVE TEAM members clearly display their designated DRIVE TEAM badges above their waists.
- E. if a Playoff MATCH, the ALLIANCE CAPTAIN clearly displays their designated ALLIANCE CAPTAIN identifier (e.g., hat or armband).

10.3.3 OPERATOR CONSOLES

DRIVE TEAMS set up their OPERATOR CONSOLES as soon as they are staged in their ALLIANCE AREA. OPERATOR CONSOLES must be compliant with all relevant rules, specifically those in section [12.9 OPERATOR CONSOLE](#). A DRIVE TEAM obstructing or delaying OPERATOR CONSOLE set up is at risk of violating [G301](#).

- A. DRIVE TEAMS intending to run an OpMode during AUTO must select an OpMode within their DRIVER STATION app with the 30 second timer enabled.
- B. Otherwise, DRIVE TEAMS must select a TELEOP OpMode within the DRIVER STATION app.
- C. The selected OpMode must be initialized by pressing the “INIT” button on the DRIVER STATION app.

10.3.4 ROBOTS

DRIVE TEAMS stage their ROBOT in accordance with [G304](#). A DRIVE TEAM obstructing or delaying ROBOT setup requirements is at risk of violating [G301](#).

If order of placement matters to either or both ALLIANCES, the ALLIANCE notifies the Head REFEREE or their designee before setting up for that MATCH, and the Head REFEREE instructs ALLIANCES to alternate placement of ROBOTS. REFEREE instructions are that ROBOTS are placed in the following order:

1. first red ROBOT
2. first blue ROBOT
3. second red ROBOT
4. second blue ROBOT

In Qualification MATCHES the ROBOT assigned to Red 1 or Blue 1 places first within their ALLIANCE. In Playoff MATCHES the ALLIANCE lead decides which ROBOT places first within their ALLIANCE.

10.4 MATCH Periods

The first period of each MATCH is 30 seconds (0:30) long and called the Autonomous Period (AUTO). During AUTO, ROBOTS operate without any DRIVER control or input. There is an 8-second delay between AUTO and TELEOP for scoring purposes as described in Section [10.5 Scoring](#).

At the *FIRST* Championship and *FIRST* Premier events, the timing of the transition between AUTO and TELEOP may vary from event to event. Details for the *FIRST* Championship are outlined in section [15.2.2 Scoring and Timing](#).

The second period of each MATCH is 2 minutes (2:00) long and called the teleoperated period (TELEOP). During TELEOP, DRIVERS remotely operate ROBOTS to score points. See Table 9-1 for detailed MATCH timing.

10.5 Scoring

ALLIANCES are rewarded for accomplishing various actions throughout a MATCH, including LEAVING their LAUNCH LINE, scoring CLASSIFIED or OVERFLOW ARTIFACTS, scoring ARTIFACTS in the DEPOT, achieving a PATTERN of ARTIFACTS, returning to their BASE, and winning or tying MATCHES.

ALLIANCES are rewarded for their performance during MATCHES via MATCH points and RANKING POINTS (RP), which increase the measure used to rank teams per section [13.6.3 Qualification Ranking](#).

All achievements are updated by FIELD STAFF throughout the MATCH. Scoring achievements are assessed as follows:

- A. Assessment of ARTIFACTS as either CLASSIFIED or OVERFLOW occurs throughout the MATCH and continues until all ARTIFACTS have come to rest following the conclusion of the MATCH. ARTIFACTS that meet scoring criteria prior to the start of TELEOP are assessed as part of AUTO
- B. Assessment of AUTO PATTERN scoring occurs at when all ARTIFACTS have come to rest following the conclusion of AUTO or the start of TELEOP, whichever comes first.
- C. Assessment of TELEOP PATTERN scoring occurs when all ROBOTS and ARTIFACTS have come to rest following the conclusion of the MATCH.
- D. Assessment of DEPOT scoring occurs at the end of TELEOP when all ROBOTS and ARTIFACTS have come to rest following the conclusion of the MATCH.
- E. Assessment of LEAVE scoring occurs at the end of AUTO.
- F. Assessment of BASE scoring occurs at the end of the TELEOP.

LEAVING the LAUNCH LINE, ARTIFACT scoring, and return to BASE points are all evaluated and scored by human volunteers. Teams are encouraged to make sure that it is obvious and unambiguous that the criteria are met.

Achievements scored before the MATCH starts, during the AUTO-to-TELEOP transition, and after the MATCH ends at 0:00 are subject to penalties.

10.5.1 ARTIFACT Scoring Criteria

To qualify for CLASSIFIED or OVERFLOW points, an ARTIFACT must enter the GOAL through the open top, exit under the archway, and pass through the diverting SQUARE. The determination of whether an ARTIFACT is CLASSIFIED or OVERFLOW is made as the ARTIFACT passes through the diverting SQUARE as follows:

- An ARTIFACT that passes through the SQUARE and transitions directly to the RAMP is considered CLASSIFIED.
- An ARTIFACT that passes through the SQUARE but does not meet CLASSIFIED criteria is considered OVERFLOW.

ARTIFACTS that do not meet all the criteria for ARTIFACT scoring (e.g., did not enter the GOAL through the open top, did not exit under the archway, or did not pass through the diverting SQUARE) do not score as either CLASSIFIED or OVERFLOW.

ARTIFACTS that are CLASSIFIED move directly to the RAMP, meaning they:

- do not roll over or otherwise bypass any ARTIFACTS on the RAMP.

ARTIFACTS that are OVERFLOW:

- pass through the SQUARE and may roll over one or more ARTIFACTS that are on the RAMP.

To qualify for DEPOT points, ARTIFACTS must be over the DEPOT.

- DEPOTS are ALLIANCE specific and are tied to the GOAL they are adjacent to.
- DEPOT points are assessed after the MATCH without regard to which ALLIANCE placed the ARTIFACTS in the DEPOT.
- DEPOTS are not protected zones, and either ALLIANCE can remove ARTIFACTS from either DEPOT during the MATCH.

An ARTIFACT over a DEPOT that is in contact with or in CONTROL of a ROBOT from either ALLIANCE will still qualify for DEPOT points for the ALLIANCE that owns the DEPOT.

Figure 10-3: Example DEPOT scoring

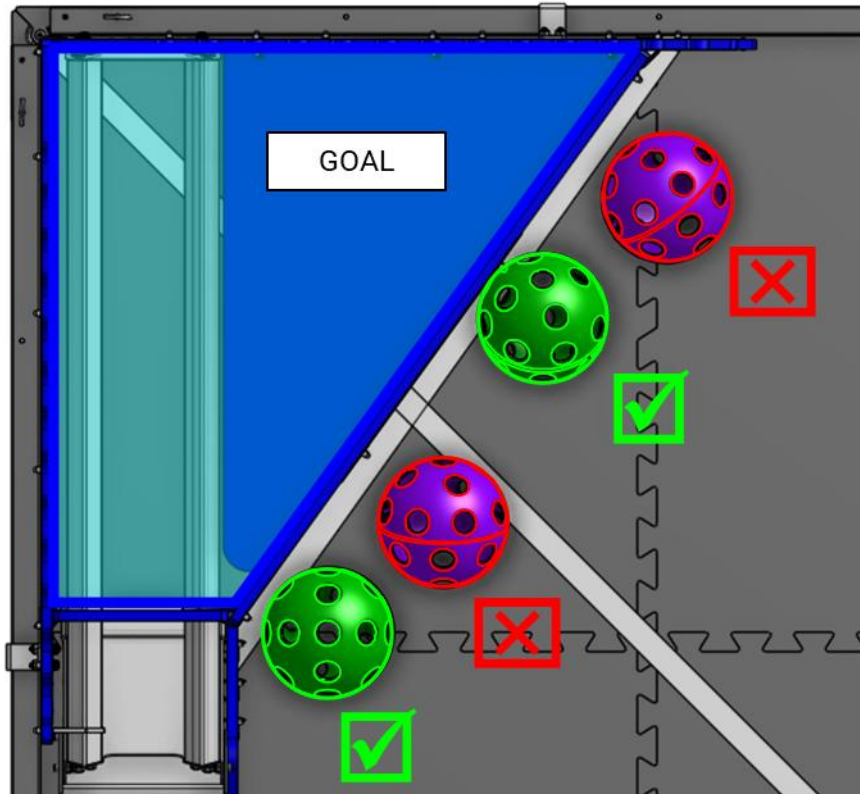

10.5.2 PATTERN Scoring Criteria

At the end of AUTO and TELEOP, ARTIFACTS that are directly on the RAMP score for PATTERN points if the color of the ARTIFACT in order matches the MOTIF color for that index, and the ARTIFACTS are retained by the GATE.

The randomization of the OBELISK prior to the start of the MATCH selects the MOTIF which is repeated 3 times to define the PATTERN colors for each of the 9 indices on the RAMP (Figure 10-4). PATTERN points are scored based on the color of the ARTIFACT on the RAMP matching the individual index color defined by the MOTIF (Figure 10-5).

Figure 10-4: MOTIFS as defined by the OBELISK

OBELISK	RAMP									SQUARE	
	Index	1	2	3	4	5	6	7	8		9
GPP (ID 21)	GATE	G	P	P	G	P	P	G	P	P	SQUARE
PGP (ID 22)	GATE	P	G	P	P	G	P	P	G	P	SQUARE
PPG (ID 23)	GATE	P	P	G	P	P	G	P	P	G	SQUARE

MOTIF

Figure 10-5: Example PATTERN scoring with GPP scoring

PATTERN Scored	<input type="checkbox"/>	<input type="checkbox"/>	<input checked="" type="checkbox"/>	<input checked="" type="checkbox"/>	<input checked="" type="checkbox"/>	<input checked="" type="checkbox"/>	<input type="checkbox"/>	<input checked="" type="checkbox"/>	<input type="checkbox"/>	
ARTIFACTS									-	
Index	1	2	3	4	5	6	7	8	9	
GATE	G	P	P	G	P	P	G	P	P	SQUARE

MOTIF (GPP)

10.5.3 ROBOT Scoring Criteria

To qualify for LEAVE points, a ROBOT must move such that it is no longer over any LAUNCH LINE at the end of AUTO.

To qualify for BASE points, a ROBOT must be either fully returned or partially returned by meeting the following conditions:

- A ROBOT fully returned to BASE must only be supported, either directly or transitively, by the TILE in the BASE ZONE.
- A ROBOT partially returned to BASE must be partially supported, either directly or transitively, by the TILE in the BASE ZONE.

The TILE in the BASE ZONE is the flooring surface bounded by the outside edge of the tape defining the BASE ZONE.

Support comes, either directly or transitively through other items on the FIELD (e.g., SCORING ELEMENTS, another ROBOT), through the TILE in the BASE ZONE.

If all of the support of the ROBOT in the BASE ZONE is from the TILE in the BASE ZONE, the ROBOT is fully returned to BASE.

If some of the support of the ROBOT in the BASE ZONE is from the TILE in the BASE ZONE and some is from TILES outside the BASE ZONE, the ROBOT is partially returned to BASE.

If none of the support of the ROBOT in the BASE ZONE is from the TILE in the BASE ZONE, the ROBOT is not considered returned to BASE.

10.5.4 Point Values

Table 10-2: DECODE point values

		MATCH points		RANKING POINTS
		AUTO	TELEOP	
LEAVE		3		
ARTIFACT	CLASSIFIED	3	3	
	OVERFLOW	1	1	
	DEPOT		1	
PATTERN	ARTIFACT matches MOTIF	2	2	
BASE	Partially returned to BASE		5	
	Fully returned to BASE		10	
	Additional Bonus: 2 ROBOTS fully returned to BASE.		10	
MOVEMENT RP – Combined LEAVE + BASE points earned at or above threshold				1
GOAL RP – The number of ARTIFACTS scored through the SQUARE at or above threshold				1
PATTERN RP – PATTERN points earned at or above threshold				1
WIN	Completing a MATCH with more MATCH points than your opponent			3
TIE	Completing a MATCH with the same MATCH points as your opponent			1

Table 10-3: DECODE RP thresholds

RP Type	FIRST Championship	Regional Championships	All Other Events*
MOVEMENT RP	21	21	16
GOAL RP	67	42	36
PATTERN RP	22	22	18

RP thresholds for Regional Championships and FIRST Championship will be announced in Team Updates.

*Premier Events will be able to set their own thresholds to best reflect the experience they want to provide teams.

10.6 Violations

FIRST Tech Challenge uses 3 words in the context of how durations and actions are assessed with regards to evaluation of rules and assignment of violations. These words provide general guidance to describe benchmarks. It is not the intent for REFEREES to provide a count during the time periods.

- MOMENTARY describes durations that are fewer than approximately 3 seconds.
- CONTINUOUS describes durations that are more than approximately 10 seconds.
- REPEATED describes actions that happen more than once within a MATCH.

Unless otherwise noted, all penalties are assigned for each instance of a rule violation, and a single action may violate multiple rules. A description of the penalties is listed in Table 10-4. All rules throughout the Game Rules section are called as perceived by a REFEREE.

Table 10-4: Rule violations

Penalty	Description
MINOR FOUL	a credit of 5 points towards the opponent's MATCH point total
MAJOR FOUL	a credit of 15 points towards the opponent's MATCH point total
YELLOW CARD	a warning issued by the Head REFEREE for egregious ROBOT or team member behavior or rule violations. A subsequent YELLOW CARD within the same tournament phase results in a RED CARD
RED CARD	a penalty issued by the Head REFEREE for egregious ROBOT or team member behavior or rule violations which results in a team being DISQUALIFIED for the MATCH.
DISABLED	The REFEREE instructs the team to stop the ROBOT which will deactivate all outputs, rendering the ROBOT inoperable for the remainder of the MATCH.
DISQUALIFIED	the state of a team in which they receive 0 MATCH points and 0 RANKING POINTS in a Qualification MATCH or causes their ALLIANCE to receive 0 MATCH points in a Playoff MATCH.
VERBAL WARNING	a warning issued by event staff or the Head REFEREE
ALLIANCE is ineligible for RP	An ALLIANCE is ineligible for the specified RP for that MATCH. This overrides any RP awarded through normal MATCH play or other rule violations.

10.6.1 YELLOW and RED CARDS

In addition to rule violations explicitly listed throughout this document, YELLOW CARDS and RED CARDS are used in FIRST Tech Challenge to address team and ROBOT behavior that does not align with the mission, values, and culture of FIRST.

The Head REFEREE may assign a YELLOW CARD as a warning, or a RED CARD for egregious behavior deemed inappropriate at a FIRST Tech Challenge event. A team that has received either a YELLOW or a RED CARD

carries a YELLOW CARD into subsequent MATCHES, except as noted below. A RED CARD results in MATCH DISQUALIFICATION.

A YELLOW or RED CARD is indicated by the Head REFEREE holding a YELLOW and/or RED CARD in the air while a member of the FIELD STAFF describes the violation to the audience.

YELLOW CARDS are additive, meaning that a second YELLOW CARD is automatically converted to a RED CARD. A team is issued a RED CARD for any subsequent incident in which they receive an additional YELLOW CARD, including earning a second YELLOW CARD during a single MATCH. A second YELLOW CARD is indicated by the Head REFEREE holding a YELLOW CARD and RED CARD in the air simultaneously after the completion of the MATCH. A team that has received either a YELLOW CARD or a RED CARD carries a YELLOW CARD into subsequent MATCHES, except as noted below. In the event MATCHES are played out-of-order, a subsequent MATCH is any chronologically later MATCH play, regardless of the originally scheduled time or the numbering of the MATCH.

Once a team receives a YELLOW or RED CARD, its team number is presented with a yellow background on the audience screen during all subsequent MATCHES, including any replays, as a reminder to the team, the REFEREES, and the audience that they carry a YELLOW CARD.

Egregious behavior by a team, which cannot be resolved locally by the Head REFEREE or Event Director working directly with the STUDENT and adult team members, will be escalated to FIRST Headquarters. In consultation with FIRST Headquarters the team may be DISQUALIFIED from all subsequent MATCHES and removed from awards consideration.

Figure 10-6: Example audience screen graphic showing YELLOW CARD indicators



All YELLOW CARDS are cleared at the conclusion of Practice, Qualification, and division Playoff MATCHES. VERBAL WARNINGS issued by the Head REFEREE are cleared after Practice MATCHES and persist from Qualification MATCHES through subsequent tournament phases, except when stated otherwise.

10.6.2 YELLOW and RED CARD application

YELLOW and RED CARDS are applied based on the following:

Table 10-5: YELLOW and RED CARD application

Time YELLOW or RED CARDS earned:	MATCH to which CARD is applied:
Prior to Qualification MATCHES	REFEREES may or may not be present at the FIELD before the start of Qualification MATCHES. With input from event staff, the Head REFEREE may opt to perpetuate a VERBAL WARNING or YELLOW CARD earned prior to Qualification MATCHES to

Time YELLOW or RED CARDS earned:	MATCH to which CARD is applied:
	the first Qualification MATCH for particularly egregious behavior.
during the Qualification MATCHES	team's current (or just completed) MATCH in which they are not a SURROGATE. For SURROGATE MATCHES the card is applied to the team's previous Qualification MATCH.
between the end of Qualification MATCHES and the start of Playoff MATCHES	ALLIANCE'S first Playoff MATCH
during the Playoff MATCHES	ALLIANCE'S current (or just completed) MATCH

A MATCH is no longer the current MATCH once the results of the MATCH have been posted or the Head REFEREE or their designee has indicated that teams can collect their ROBOTS, whichever is later.

Please see examples of the application of YELLOW and RED CARDS as shown in section [10.6.4 Violation Details](#).

10.6.3 YELLOW and RED CARDS during Playoff MATCHES

During Playoff MATCHES, YELLOW and RED CARDS are assigned to the violating team's entire ALLIANCE instead of to only the violating team. If an ALLIANCE receives 2 YELLOW CARDS, the entire ALLIANCE is issued a RED CARD which results in DISQUALIFICATION for the associated MATCH.

10.6.4 Violation Details

There are several styles of violation wording used in this manual. Below are some example violations and a clarification of the way the violation would be assessed. The examples shown do not represent all possible violations, but rather a representative set of combinations.

Table 10-6: Violation examples

Example Violation	Expanded Interpretation
MINOR FOUL	Upon violation, a MINOR FOUL is assessed against the violating ALLIANCE.
MAJOR FOUL and YELLOW CARD	Upon violation, a MAJOR FOUL is assessed against the violating ALLIANCE. After the MATCH, the Head REFEREE presents the violating team with a YELLOW CARD.
MINOR FOUL per SCORING ELEMENT over the limit.	Upon violation, a number of MINOR FOULS are assessed against the violating ALLIANCE equal to the number of additional SCORING ELEMENTS beyond the permitted quantity.

Example Violation	Expanded Interpretation
<p>MINOR FOUL. MAJOR FOUL if REPEATED.</p>	<p>Upon initial violation in a MATCH, a MINOR FOUL is assessed against the violating ALLIANCE. If the condition in the second statement is met: the ROBOT repeats the infraction in the MATCH, then a MAJOR FOUL is assessed against the violating ALLIANCE. Assuming no additional infractions of that rule by that ROBOT in that MATCH, the ROBOT is assessed a MINOR FOUL and a MAJOR FOUL for their ALLIANCE.</p>
<p>MINOR FOUL and an additional MINOR FOUL for every 3 seconds in which the situation is not corrected</p>	<p>Upon violation, a MINOR FOUL is assessed against the violating ALLIANCE and the REFEREE begins to count. Their count continues until the criteria to discontinue the count are met, and for each 3 seconds within that time, an additional MINOR FOUL is assessed against the violating ALLIANCE. A ROBOT in violation of this type of rule for 15 seconds is assessed a total of 6 MINOR FOULS (assuming no other rules were being simultaneously violated).</p>
<p>MAJOR FOUL and the opposing ALLIANCE is awarded the PATTERN RP.</p>	<p>Upon violation, a MAJOR FOUL is assessed against the violating ALLIANCE and the opposing ALLIANCE is awarded the PATTERN RP, regardless of the status of the scoring achievements during the MATCH.</p>
<p>MAJOR FOUL plus YELLOW CARD if REPEATED.</p>	<p>Upon violation, a MAJOR FOUL is assessed against the violating team. If the condition “if REPEATED” (e.g., a subsequent violation by the same team in the same MATCH) is met, then the violating team is issued another MAJOR FOUL. If these are the only violations during the MATCH: after the MATCH, the Head REFEREE presents the violating team with a YELLOW CARD for the second violation of this rule. In total, 2 MAJOR FOULS and a YELLOW CARD were assessed during the MATCH.</p>
<p>VERBAL WARNING. YELLOW CARD if subsequent violations occur during the event.</p>	<p>Upon violation, a VERBAL WARNING is issued to the violating team. If an additional violation of the same rule occurs later in the event, including during the same MATCH, a later MATCH during the same event phase, or during a later event phase, then following the subsequent violations: after the MATCH, the Head REFEREE presents the violating team with a YELLOW CARD.</p>

Example Violation	Expanded Interpretation
<p>MAJOR FOUL and YELLOW CARD. MAJOR FOUL and RED CARD if opponent ROBOT is unable to drive.</p>	<p>Upon a general violation of this rule, a MAJOR FOUL is assessed against the violating ALLIANCE. After the MATCH, the Head REFEREE presents the violating team with a YELLOW CARD.</p> <p>However, if the opponent ROBOT is unable to drive, then upon violation, a MAJOR FOUL is assessed against the violating ALLIANCE. After the MATCH, the Head REFEREE presents the violating team with a RED CARD.</p> <p>Only 1 MAJOR FOUL is earned for a single violation.</p>

10.7 Head REFEREE

The Head REFEREE has the ultimate authority in the ARENA during the event but may receive input from additional sources, e.g., FIRST personnel, FTA, Event Director, or other event staff. The Head REFEREE rulings are final. No event staff, including the Head REFEREE, will review video, photos, artistic renderings, etc. of any MATCH, from any source, under any circumstances.

10.8 Other Logistics

SCORING ELEMENTS that leave the FIELD will be returned to the closest ARTIFACT tray or available DRIVER or HUMAN PLAYER at the earliest safe opportunity by FIELD STAFF. Reintroduction of SCORING ELEMENTS must follow rule [G432](#).

An ARENA FAULT (an error in ARENA operation described in section [13.3 MATCH Replays](#)) is not called for MATCHES that accidentally begin with damaged SCORING ELEMENTS, the incorrect number of SCORING ELEMENTS, or incorrectly placed SCORING ELEMENTS. Damaged SCORING ELEMENTS are not replaced until the next MATCH reset. DRIVE TEAMS should alert the FIELD STAFF to any missing, incorrectly placed, or damaged SCORING ELEMENTS prior to the start of the MATCH. During a MATCH, FIELD STAFF may follow steps in the [Field Mitigation Guide](#) to mitigate some FIELD issues during a MATCH.

Once the MATCH is over and the Head REFEREE or their designee determines that the FIELD and FIELD STAFF are ready, they will signal for DRIVE TEAMS to stop their ROBOTS, and to initiate FIELD reset and DRIVE TEAMS to retrieve their ROBOTS.

During MATCH reset, the FIELD is cleared of ROBOTS and OPERATOR CONSOLES from the MATCH that just ended, ROBOTS and OPERATOR CONSOLES for the subsequent MATCH are loaded into the FIELD by DRIVE TEAMS, and FIELD STAFF reset ARENA elements.

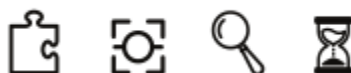

11 Game Rules (G)

11.1 Personal Safety

G101 *Humans, stay off the FIELD during the MATCH. Other than actions explicitly allowed in section [11.4.6 Human](#), a DRIVE TEAM member may only enter the FIELD during the following times:

- A. pre-MATCH set-up in order to place their ROBOT and pre-loaded SCORING ELEMENTS per [G301](#), [G303](#), and [G304](#), and
- B. after a MATCH is over to stop and collect their ROBOT in a reasonable amount of time when instructed to do so by the Head REFEREE or their designee.

Violation: VERBAL WARNING.

A team may not delay the FIELD reset process through an excessively lengthy process to remove the ROBOT from the FIELD.

It is not a violation of this rule if DRIVE TEAM members contribute to FIELD reset by placing SCORING ELEMENTS that they inadvertently move while setting up their ROBOT or placing removed SCORING ELEMENTS on the FIELD.

Egregious violations of this rule, such as entering the FIELD during a MATCH, are covered by [G211](#).

G102 *Be careful when interacting with ARENA elements. A team member is prohibited from the following actions with regards to interaction with ARENA elements:

- A. climbing on,
- B. hanging from,
- C. manipulating such that it does not return to its original shape without human intervention, and
- D. damaging.

Violation: VERBAL WARNING. YELLOW CARD if subsequent violations occur during the event.

DRIVE TEAM members may brace the FIELD perimeter at any point during the MATCH. Moving the FIELD perimeter out of position is considered a violation of [G102.C](#).

11.2 Conduct

G201 *Be a good person. All teams must be civil toward everyone and respectful of team and event equipment while at a FIRST Tech Challenge event. Please review the FIRST [Code of Conduct](#) and [Core Values](#) for more information.

Violation: VERBAL WARNING. YELLOW CARD if subsequent violations occur during the event.

Examples of inappropriate behavior include, but are not limited to, the use of offensive language or other uncivil conduct.

Examples of particularly contemptible behavior that is likely to result in ARENA ejection include, but are not limited to, the following:

- A. assault, e.g., throwing something that hits another person (even if unintended),
- B. threat, e.g., saying something like “if you don’t reverse that call, I’ll make you regret it,”
- C. harassment, e.g., badgering someone with no new information after a decision has been made or a question has been answered,
- D. bullying, e.g., using body or verbal language to cause another person to feel inadequate,
- E. insulting, e.g., telling someone they don’t deserve to be on a DRIVE TEAM,
- F. swearing at another person (versus swearing under one’s breath or at oneself), and
- G. yelling at another person(s) in anger or frustration.

G202 *DRIVE TEAM Interactions. DRIVE TEAM members cannot distract/interfere with the opposing ALLIANCE. This includes taunting or other disruptive behavior.

Violation: VERBAL WARNING. YELLOW CARD if subsequent violations occur during the event.

G203 *Asking other teams to throw a MATCH – not cool. A team may not encourage an ALLIANCE of which it is not a member to play beneath its ability.

NOTE: This rule is not intended to prevent an ALLIANCE from planning and/or executing its own strategy in a specific MATCH in which all the teams are members of the ALLIANCE.

Violation: VERBAL WARNING. RED CARD if subsequent violations occur during the event.

Example 1: A MATCH is being played by Teams A and B. Team C requests Team A to open the GATE at the end of the MATCH in order resulting in teams A and B not earning the PATTERN RP. Team A accepts this request from team C. Team C’s motivation for this behavior is to prevent Team B from rising in the Tournament rankings and negatively affect Team C’s ranking. Team C has violated this rule.

Example 2: A MATCH is being played by teams A and B, in which team A is assigned to participate as a SURROGATE. Team D encourages team A not to participate in the MATCH so that team D gains ranking position over team B. Team D has violated this rule.

FIRST considers the action of a team influencing another team to throw a MATCH, to deliberately miss RANKING POINTS, etc. incompatible with FIRST values and not a strategy any team should employ.

G204 *Letting someone coerce you into throwing a MATCH – also not cool. A team, as the result of encouragement by a team not on their ALLIANCE, may not play beneath its ability.

NOTE: This rule is not intended to prevent an ALLIANCE from planning and/or executing its own strategy in a specific MATCH in which all the ALLIANCE members are participants.

Violation: VERBAL WARNING. RED CARD if subsequent violations occur during the event.

Example 1: A MATCH is being played by Teams A and B. Team C requests Team A to open the GATE at the end of the MATCH in order resulting in teams A and B not earning the PATTERN RP. Team A accepts this request from team C. Team C's motivation for this behavior is to prevent Team B from rising in the Tournament rankings and negatively affect Team C's ranking. Team A has violated this rule.

Example 2: A MATCH is being played by Teams A and B, in which Team A is assigned to participate as a SURROGATE. Team A accepts Team D's request to not participate in the MATCH so that Team D gains ranking position over Team B. Team A has violated this rule.

FIRST considers the action of a team influencing another team to throw a MATCH, to deliberately miss RANKING POINTS, etc. incompatible with FIRST values and not a strategy any team should employ.

- G205** ***Throwing your own MATCH is bad.** A team may not intentionally lose a MATCH or sacrifice RANKING POINTS in an effort to lower their own ranking and/or manipulate the rankings of other teams.

Violation: VERBAL WARNING. RED CARD if subsequent violations occur during the event.

The intent of this rule is not to punish teams who are employing alternate strategies, but rather to ensure that it is clear that throwing MATCHES to negatively affect your own rankings, or to manipulate the rankings of other teams (e.g., throw a MATCH to lower a partner's ranking, and/or increase the ranking of another team not in the MATCH) is incompatible with FIRST values and not a strategy any team should employ.

- G206** ***Don't violate rules for RPs.** A team or ALLIANCE may not collude with another team to each purposefully violate a rule in an attempt to influence RANKING POINTS.

Violation: YELLOW CARD and the ALLIANCE is ineligible for PATTERN and GOAL RPs

For example, if Team A on the blue ALLIANCE agrees with Team D on the red ALLIANCE to disrupt each other's GATE in violation of [G417](#) resulting in both ALLIANCES being awarded the PATTERN RP.

- G207** ***Do not abuse ARENA access.** A team member (except those DRIVE TEAM members on the DRIVE TEAM for the MATCH) granted access to restricted areas in and around the ARENA (e.g., via event issued media badges) may not assist, coach, or use signaling devices during the MATCH. Exceptions will be granted for inconsequential infractions and in cases concerning safety.

Violation: VERBAL WARNING. YELLOW CARD if subsequent violations occur during the event.

Team members in open-access spectator seating areas are not considered to be in a restricted area and are not prevented from assisting or using signaling devices. See [E102](#) for related details.

G208 *Show up to your MATCHES. If a ROBOT has passed initial, complete inspection, at least 1 member of its DRIVE TEAM must report to the ARENA and participate in each of their assigned Qualification MATCHES.

Violation: DISQUALIFIED from the current MATCH.

The team should inform the Lead Queuer if the team's ROBOT is not able to participate.

G209 *Keep your ROBOT together. A ROBOT may not intentionally detach or leave a part on the FIELD.

Violation: RED CARD.

G210 *Do not expect to gain by doing others harm. Actions clearly aimed at forcing the opponent ALLIANCE to violate a rule are not in the spirit of FIRST Tech Challenge and not allowed. Rule violations forced in this manner will not result in an assignment of a penalty to the targeted ALLIANCE.

Violation: MINOR FOUL. MAJOR FOUL if REPEATED. The ALLIANCE that was forced to break a rule will not be assessed a penalty.

This rule does not apply for strategies consistent with standard gameplay, for example:

A. a red ROBOT attempting to access its GATE pushes a blue ROBOT into an ARTIFACT on the red RAMP.

This rule requires an intentional act with limited or no opportunity for the team being acted on to avoid the penalty, such as:

B. a blue ALLIANCE ROBOT pushing a red ALLIANCE ROBOT from "far away" (more than one TILE distance away) into the blue ALLIANCE LOADING ZONE.

C. Placing an ARTIFACT into an opponent ROBOT such that it is in violation of [G408](#).

G211 *Egregious or exceptional violations. Egregious behavior beyond what is listed in the rules or subsequent violations of any rule or procedure during the event is prohibited.

In addition to rule violations explicitly listed in this manual and witnessed by a REFEREE, the Head REFEREE may assign a YELLOW or RED CARD for egregious ROBOT actions or team member behavior at any time during the event.

Continued violations will be brought to FIRST Headquarters' attention. FIRST Headquarters will work with event staff to determine if further escalations are necessary, which can include removal from award consideration and removal from the event.

Please see section [10.6.1 YELLOW and RED CARDS](#) for additional detail.

Violation: YELLOW or RED CARD.

The intent of this rule is to provide the Head REFEREES with the flexibility necessary to keep the event running smoothly, as well as keep the safety of all the participants as the highest priority. There are certain behaviors that automatically result in a YELLOW or RED CARD because this behavior puts the

FIRST community at risk. Those behaviors include, but are not limited to the list below:

- A. inappropriate behavior as outlined in the orange box of [G201](#),
- B. reaching into the FIELD and grabbing a ROBOT during a MATCH,
- C. a single PIN in excess of 15 seconds,
- D. descoring SCORING ELEMENTS strategically or REPEATEDLY

The Head REFEREE may assign a YELLOW or RED CARD for a single instance of a rule violation such as the examples given in items above, or for multiple instances of any single rule violation. Teams should be aware that any rule in this manual could escalate to a YELLOW or RED CARD. The Head REFEREE has final authority on all rules and violations at an event.

G212 *All teams can play. A team may not encourage another team to exclude their ROBOT or be DISQUALIFIED from a Qualification MATCH for any reason.

Violation: YELLOW CARD. RED CARD if the ROBOT does not participate in the MATCH

11.3 Pre-MATCH

G301 *Be prompt. A DRIVE TEAM member may not cause significant delays to the start of their MATCH. Causing a significant delay requires both of the following to be true:

- A. The expected MATCH start time has passed, and

During Qualification MATCHES, the expected start time of the MATCH is the time indicated on the MATCH schedule or ~3 minutes from the end of the previous MATCH on the same FIELD, whichever is later. If [T206](#) is in effect, the expected MATCH start time is the later of the end of the [T206](#) time or the time indicated on the schedule.

During Playoff MATCHES, the expected start time of the MATCH is the time indicated on the MATCH schedule or 8 minutes from either ALLIANCE'S previous MATCH, whichever is later.

- B. The DRIVE TEAM has access to the ARENA and is neither MATCH ready nor making a good faith effort, as perceived by the Head REFEREE, to quickly become MATCH ready.

Teams that have violated [G208](#) or have 1 DRIVE TEAM member present and have informed event staff that their ROBOT will not be participating in the MATCH are considered MATCH ready and not in violation of this rule.

Violation:

If a Qualification MATCH: VERBAL WARNING. MAJOR FOUL for the upcoming MATCH if a subsequent violation occurs within the tournament phase. If the DRIVE TEAM is not MATCH ready within 2 minutes of the VERBAL WARNING/MAJOR FOUL, and the Head REFEREE perceives no good faith effort by the DRIVE TEAM to quickly become MATCH ready, DISABLED.

If a Playoff MATCH: a VERBAL WARNING is issued to the ALLIANCE. MAJOR FOUL for the ALLIANCE'S upcoming MATCH if a subsequent violation occurs within the tournament phase. If the ALLIANCE is not MATCH ready within 2 minutes of the VERBAL WARNING/MAJOR FOUL having been issued, and the Head REFEREE perceives no good faith effort by the DRIVE TEAM(s) to quickly become MATCH ready, the offending team's ROBOT is DISABLED.

The intent of this rule is to provide an equitable amount of time for both ALLIANCES to prepare for each MATCH and give DRIVE TEAMS grace given extenuating circumstances that cause them to be late.

Once a VERBAL WARNING/MAJOR FOUL is issued, the Head REFEREE starts a 2-minute timer and makes a good faith effort to share the timer's status with the delaying DRIVE TEAM.

Being "MATCH ready" requires that the ROBOT is on the FIELD, in its STARTING CONFIGURATION, and turned on. Additionally, the DRIVE TEAM members must be in their starting positions.

In general, good faith efforts to quickly become MATCH ready are entirely for the purposes of transitioning the ROBOT into a MATCH ready state (i.e., not attempts to significantly alter a ROBOT'S capabilities.) Examples of good faith efforts to quickly become MATCH ready include but are not limited to:

- A. walking safely towards the FIELD with a ROBOT that a team is not actively modifying.
- B. applying quick fixes such as tape or cable ties to make the ROBOT compliant with STARTING CONFIGURATION requirements.
- C. waiting for a DRIVER STATION device to boot.
- D. actively working with field technical staff, including the FTA, to resolve an issue in a reasonable amount of time.
- E. performing a MOMENTARY "wobble test" to confirm communication between the DRIVER STATION and the ROBOT CONTROLLER. The ROBOT should not drive or interact with SCORING ELEMENTS (except contact with pre-loaded ARTIFACTS) while performing this test.

G302 *Limit what you bring to the FIELD. Items brought to the FIELD to be used for a MATCH, in addition to the ROBOT, OPERATOR CONSOLE, must fit in the team's designated ALLIANCE AREA, be worn or held by members of the DRIVE TEAM, or be an item used as an accommodation (e.g., single-step stools that do not roll/fold, crutches, cushion, kneeling mat,). Regardless of if the equipment fits the criteria above, it may not:

- A. be employed in a way that introduces a safety hazard,
- B. extend more than 6 ft. 6 in. (~198 cm) above the TILES,
- C. communicate with anything or anyone outside of the ARENA with the exception of medically required equipment,
- D. block visibility for FIELD STAFF or audience members, or
- E. jam or interfere with anything in the ARENA.

Violation: MATCH will not start until the situation is remedied. YELLOW CARD, if discovered or used inappropriately during a MATCH.

It is not a violation of this rule to bring an alignment device to the FIELD to aid pre-MATCH ROBOT set-up and alignment. The use of any alignment devices should not delay MATCH start in violation of [G301](#).

Examples of equipment that may be considered a safety hazard in the confined space of the ALLIANCE AREA include but are not limited to, a folding step stool, ladder, or a large signaling device.

Using an item that has wireless communications disabled complies with [G302.C](#) above.

Examples of jamming or interfering with remote sensing capabilities include, but are not limited to, mimicking the FIELD AprilTags and shining bright lighting or laser pointers onto the FIELD.

G303 *ROBOTS on the FIELD must come ready to play a MATCH. A ROBOT must meet all following MATCH-start requirements:

- A. does not pose a hazard to humans, FIELD elements, or other ROBOTS.
- B. has passed inspection, i.e., it is compliant with all ROBOT rules.
- C. if modified after initial Inspection, it is compliant with [I305](#).
- D. is the only team-provided item left in the FIELD.
- E. ROBOT SIGNS must indicate the correct ALLIANCE color (see [R402](#)).
- F. ROBOT must be motionless following completion of OpMode initialization.

If a ROBOT is DISABLED prior to the start of the MATCH, the DRIVE TEAM may not remove the ROBOT from the FIELD without permission from the Head REFEREE or the FTA.

For assessment of many of the items listed above, the Head REFEREE is likely to consult with the LRI.

Violation: The MATCH will not start until all requirements are met if there is a quick remedy. DISABLED if it is not a quick remedy, and, at the discretion of the Head REFEREE, ROBOT must be re-inspected. RED CARD if a team's ROBOT is not compliant with part [B](#) or [C](#) participates.

G304 *ROBOTS must be set up correctly on the FIELD. A ROBOT must be positioned on the FIELD such that it meets all of the following requirements:

- A. is over a LAUNCH LINE,
- B. is either touching its own ALLIANCE's GOAL or the FIELD perimeter,
- C. is fully contained on its own ALLIANCE's side of the FIELD (FIELD columns A, B, C for blue, or FIELD columns D, E, F for red) (Figure 9-4),
- D. not attached to, entangled with, or suspended from any FIELD element,
- E. confined to its STARTING CONFIGURATION (see [R101](#) and [R102](#)), and
- F. in contact with no more than the allowed pre-load possession limit as described in section [10.3.1 SCORING ELEMENTS](#).

Violation: The MATCH will not start until all requirements are met if there is a quick remedy. DISABLED if it is not a quick remedy.

[G304.C](#) requires the ROBOT to be fully contained within the FIELD perimeter and not overhang the FIELD perimeter wall.

Figure 11-1 shows examples of several possible legal ROBOT starting locations.

Figure 11-1: Examples of allowed ROBOT starting locations

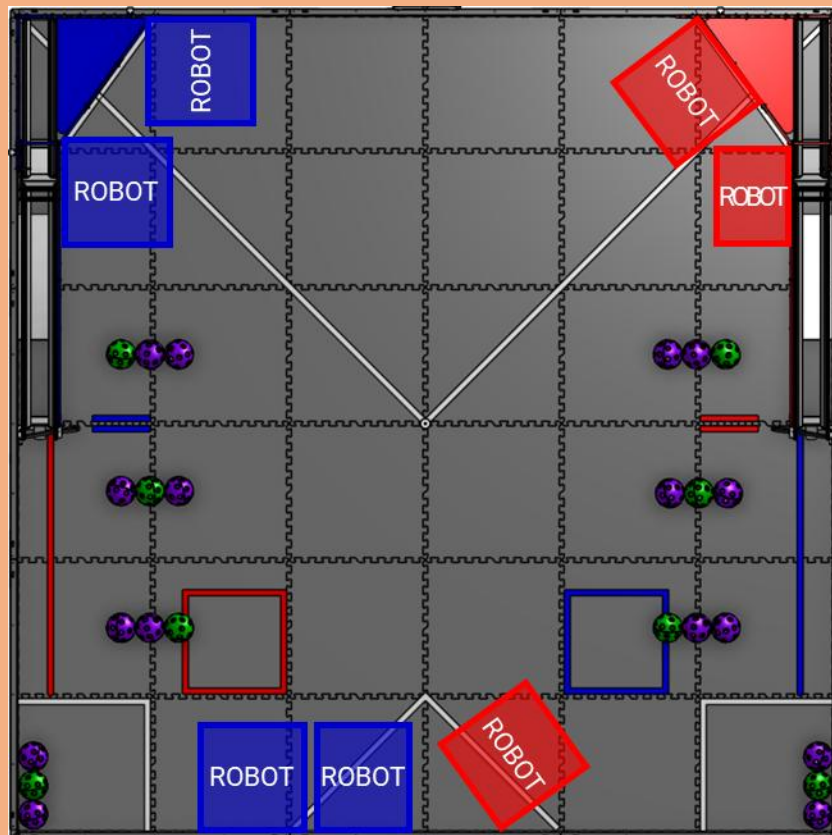

G305 *Teams must select an OpMode. An OpMode must be selected on the DRIVER STATION app and initialized by pressing the INIT button. If this OpMode is an AUTO OpMode, the 30 second AUTO timer must be enabled.

Violation: MATCH will not start until the situation is remedied. DISABLED if ROBOT cannot initialize an OpMode or the situation cannot be remedied quickly.

This rule requires all teams to select and INIT an OpMode regardless of whether or not an AUTO OpMode is planned to be used during AUTO. FIELD STAFF will use this as an indication that a team is ready to start the MATCH.

Teams without an AUTO OpMode should consider creating a default AUTO OpMode using the BasicOpMode sample and use the [auto-loading feature](#) to automatically queue up their TELEOP OpMode.

11.4 In-MATCH

Rules in this section pertain to gameplay once a MATCH begins.

11.4.1 AUTO

AUTO is the first 30 seconds of the MATCH, during which DRIVERS may not provide input to their ROBOTS, so ROBOTS operate with only their pre-programmed instructions.

G401 *Let the ROBOT do its thing. As soon as FIELD STAFF begins the randomization process and until the end of AUTO, DRIVE TEAM members may not directly or indirectly interact with a ROBOT or an OPERATOR CONSOLE, with the following exceptions:

- A. to press the (▶) start button within a MOMENTARY reaction of the start of the MATCH,
- B. to press the (■) stop button either at the team's discretion or instruction of the Head REFEREE per [T202](#), or
- C. for personal safety or OPERATOR CONSOLE safety.

Violation: MAJOR FOUL plus the ALLIANCE is not eligible for PATTERN points in AUTO if the ROBOT LAUNCHES an ARTIFACT such that it enters the open top of the GOAL after the interaction and before the end of AUTO.

FIELD STAFF will not re-randomize the OBELISK due to violations of this rule prior to MATCH start.

Teams do not have to start an OpMode if they choose not to run an AUTO OpMode.

The intent of [G401.A](#) is for teams to start AUTO on time, accounting for the variability in human factors. Strategic violations of [G401.A](#) will be considered egregious behavior under [G211](#).

G402 No AUTO opponent interference. During AUTO, FIELD columns A, B, C constitute the blue side of the FIELD, and columns D, E, F (Figure 9-5) constitute the red side of the FIELD. During AUTO, a ROBOT may not:

- A. contact an opposing ALLIANCE'S ROBOT which is completely within the opposing ALLIANCE'S side of the FIELD either directly or transitively through an ARTIFACT, or
- B. disrupt an ARTIFACT from its pre-staged location on the opposing ALLIANCE'S side of the FIELD either directly or transitively through contact with an ARTIFACT, or by LAUNCHING an ARTIFACT directly into it.

Violation: MAJOR FOUL per instance of ROBOT contact in [G402.A](#) and MAJOR FOUL per ARTIFACT in [G402.B](#).

Navigating into the opposing ALLIANCE'S side of the FIELD during AUTO is a risky gameplay strategy.

LAUNCHED ARTIFACTS which happen to enter the other side of the FIELD after being deflected by another object in the FIELD (e.g., FIELD element, ROBOT) will not be penalized.

Example 1: A red ROBOT LAUNCHES 1 ARTIFACT onto the opponent side of the FIELD. The LAUNCHED ARTIFACT disrupts 2 pre-staged ARTIFACTS on the blue side of the FIELD. Red is assessed 2 MAJOR FOULS under [G402](#).

Example 2: A red ROBOT LAUNCHES 1 ARTIFACT at their GOAL in an attempt to score, but the ARTIFACT misses the open top of the GOAL, deflects off the GOAL structure and rolls into the blue side of the FIELD, disrupting 2 pre-staged ARTIFACTS. No [G402](#) penalties are assessed.

11.4.2 TELEOP

G403 ***ROBOTS are motionless between AUTO and TELEOP.** Any powered movement of the ROBOT or any of its MECHANISMS is not allowed during the transition period between AUTO and TELEOP.

Violation: MAJOR FOUL.

Movement that occurs following the conclusion of an AUTO OpMode (due to inertia, gravity, or de-energizing of actuators, etc.) is not a violation of this rule.

Teams may press buttons on their DRIVER STATION app to stop the AUTO OpMode, initialize or start a TELEOP OpMode during the AUTO to TELEOP transition period. If the INIT portion of the OpMode causes the ROBOT to violate this rule (actuators moving or twitching in any way) then the team should wait until TELEOP begins before pressing INIT.

A ROBOT LAUNCHING an ARTIFACT during the transition period is considered a violation of this rule.

Strategic violations of this rule will be considered egregious behavior under [G211](#). Strategic violations include, but are not limited to:

- LAUNCHING multiple SCORING ELEMENTS,
- operating the GATE, and
- moving the ROBOT a substantial distance in a preferred direction.

G404 ***ROBOTS are motionless at the end of TELEOP.** ROBOTS must no longer have powered movement after the end of TELEOP until the Head REFEREE or their designee signals that teams may retrieve their ROBOTS.

Violation: MINOR FOUL. MAJOR FOUL per ARTIFACT if ROBOT LAUNCHES an ARTIFACT such that it enters the open top of a GOAL after the end of TELEOP. MAJOR FOUL if ROBOT contacts a GATE after the end of TELEOP.

DRIVE TEAMS should make it obvious that the ROBOTS are no longer being controlled by pressing the (■) stop button on the DRIVER STATION app or by discontinuing any operation of the ROBOT by the end of the MATCH period and setting down their controllers.

Movement due to inertia, gravity, or de-energizing of actuators, etc. is not considered powered movement.

11.4.3 SCORING ELEMENT

G405 ***ROBOTS use SCORING ELEMENTS as directed.** A ROBOT may not deliberately use a SCORING ELEMENT in an attempt to ease or amplify a challenge associated with a FIELD element other than as intended.

Violation: MAJOR FOUL per SCORING ELEMENT.

Examples include, but are not limited to:

- A. Intentionally positioning SCORING ELEMENTS to impede opponent access to FIELD elements
- B. Intentionally placing SCORING ELEMENTS into inaccessible locations on the FIELD such as under the RAMP or GOAL
- C. Intentionally using a SCORING ELEMENT to hold open the GATE

G406 *Keep SCORING ELEMENTS in bounds. A ROBOT may not intentionally eject a SCORING ELEMENT from the FIELD (either directly or by bouncing off a FIELD element or another ROBOT).

Violation: MAJOR FOUL per SCORING ELEMENT.

SCORING ELEMENTS that leave the FIELD during scoring attempts are not considered intentional ejections.

G407 *Do not damage SCORING ELEMENTS. Neither a ROBOT nor a DRIVE TEAM member may damage a SCORING ELEMENT.

Violation: VERBAL WARNING. MAJOR FOUL if REPEATED. DISABLED if the damage is caused by a ROBOT, and the Head REFEREE determines that further damage is likely to occur. Corrective action (such as eliminating sharp edges, removing the damaging MECHANISM, and/or reinspection) may be required before the ROBOT may compete in subsequent MATCHES.

SCORING ELEMENTS are expected to undergo a reasonable amount of wear and tear as they are handled by ROBOTS and humans, such as scratching, marking, and eventually damage due to fatigue. Routinely gouging, tearing off pieces, or marking SCORING ELEMENTS are violations of this rule.

G408 No more than 3 at a time. A ROBOT may not simultaneously CONTROL more than 3 ARTIFACTS.

Violation: MINOR FOUL per SCORING ELEMENT over the limit. YELLOW CARD if excessive.

Examples of interaction with a SCORING ELEMENT that are not “CONTROL” include, but are not limited to:

- A. “bulldozing” (inadvertent contact with a SCORING ELEMENT while in the path of the ROBOT moving about the FIELD)
- B. “deflecting” (being hit by a SCORING ELEMENT that bounces into or off a ROBOT)
- C. inadvertent contact with a SCORING ELEMENT while attempting to acquire a SCORING ELEMENT from the LOADING ZONE.
- D. SCORING ELEMENTS that have been LAUNCHED by a ROBOT that are no longer in contact with the ROBOT.

It is important to design your ROBOT so that it is impossible to inadvertently or unintentionally CONTROL more than the limit.

Excessive violations of CONTROL limits include, but are not limited to:

- A. simultaneous CONTROL of 5 or more ARTIFACTS, or
- B. frequent (i.e., 3 or more separate violations in a MATCH), greater-than-MOMENTARY CONTROL of 4 or more ARTIFACTS.

REPEATED excessive violations of this rule do not result in additional YELLOW CARDS unless the violation reaches the level of egregious to trigger a [G211](#) violation.

11.4.4 ROBOT

G409 *ROBOTS must be under control. A ROBOT must not pose an undue hazard to a human or an ARENA element during a MATCH in the following ways:

- A. the ROBOT or anything it CONTROLS, i.e., a SCORING ELEMENT, disrupts anything outside the FIELD or contacts a human that is outside the FIELD.
- B. the ROBOT operation is dangerous.

Violation: DISABLED and VERBAL WARNING. YELLOW CARD if REPEATED or if subsequent violations occur during the event.

Please be conscious of REFEREES and FIELD STAFF working around the ARENA who may be in close proximity to your ROBOT.

Examples of violations include, but are not limited to:

- A. Wildly flailing outside the FIELD
- B. Knocking over a DRIVER STATION stand
- C. Moving/damaging the FIELD timer display
- D. Contacting FIELD STAFF or a DRIVE TEAM member outside the FIELD

ROBOT contact with ARENA elements outside the FIELD, such as a DRIVER STATION stand, the floor outside the FIELD, or the FIELD wall perimeter outside of the FIELD is not a violation of this rule.

Disrupting the OBELISK is not a violation of this rule.

G410 *ROBOTS must stop when instructed. If a team is instructed to DISABLE their ROBOT by a REFEREE per [T202](#), a DRIVE TEAM member must press the (■) stop button on the DRIVER STATION app.

Violation: MAJOR FOUL if greater-than-MOMENTARY delay plus RED CARD if CONTINUOUS.

G411 *ROBOTS must be identifiable. A ROBOT'S team number and ALLIANCE color must not become indeterminate by determination of the Head REFEREE.

Violation: VERBAL WARNING. MINOR FOUL if subsequent violations occur during the event.

Teams are encouraged to robustly affix their ROBOT SIGNS to their ROBOT in highly visible locations such that they do not easily fall off or become obscured during normal gameplay.

G412 *Don't damage the FIELD. A ROBOT may not damage FIELD elements.

Violation: VERBAL WARNING. DISABLED if the Head REFEREE infers that additional damage is likely. YELLOW CARD for any subsequent damage during the event. Corrective action (such as eliminating sharp edges, removing the damaging MECHANISM, and/or re-inspection) may be required before the ROBOT will be allowed to compete in subsequent MATCHES.

SCORING ELEMENT damage is specifically covered in [G407](#), [G407](#) and [G412](#) do not stack. [G412](#) does not apply to damage caused by normal gameplay actions.

FIELD damage includes, but is not limited to:

- contaminating the FIELD with a liquid or fine solid as in [R205](#),
- damaging TILE in [R201](#),
- causing the GATE to bend or break off

FIELD damage does not include:

- normal GATE interaction resulting in a GATE that “sticks” open
- normal interaction with the GOAL that causes it to lift off the TILES

G413 ***Watch your ARENA interaction.** A ROBOT is prohibited from the following interactions with an ARENA element, except for SCORING ELEMENTS (per [G407](#)):

- grabbing,
- grasping,
- attaching to,
- becoming entangled with, or
- suspending from.

Violation: MAJOR FOUL plus YELLOW CARD if REPEATED or if greater-than-MOMENTARY. DISABLED if the Head REFEREE infers that damage is likely. Corrective action (such as removing the offending MECHANISM, and/or re-inspection) may be required before the ROBOT will be allowed to compete in subsequent MATCHES.

ROBOTS operating the GATE should make it clear that they do not violate this rule. ROBOTS are expected to push the GATE lever down to open, but no closing force (e.g., pulling) should be applied.

G414 **ROBOTS have horizontal expansion limits.** ROBOTS must comply with the horizontal expansion limits outlined in [R105.A](#) during the MATCH. Exceptions:

- If the over-expansion is due to damage and not used for strategic benefit.

Violation: MINOR FOUL. MAJOR FOUL if the over-expansion is used for strategic benefit, including if it impedes or enables a scoring action.

ROBOTS are allowed to have moving parts that extend outside its STARTING CONFIGURATION, but these extensions must stay within the expansion limit as described in [R105](#).

G415 **ROBOTS have vertical expansion limits, with exceptions.** ROBOTS must comply with the vertical expansion limits outlined in [R105](#). ROBOTS may only expand above 18 in. (45.70 cm) up to 38 in. (96.50 cm) if both of the following conditions are true:

- during the final 20 seconds of the MATCH, and
- when not in any LAUNCH ZONES.

Violation: *MINOR FOUL. MAJOR FOUL if the over-expansion is used for strategic benefit, including if it impedes or enables a scoring action.*

ROBOTS are allowed to have moving parts that extend outside its STARTING CONFIGURATION, but these extensions must stay within the expansion limit as described in [R105](#).

G416 LAUNCHING in the LAUNCH ZONE only. ROBOTS may only LAUNCH SCORING ELEMENTS when inside a LAUNCH ZONE or overlapping a LAUNCH LINE.

Violation: *MINOR FOUL per LAUNCHED SCORING ELEMENT. MAJOR FOUL per LAUNCHED SCORING ELEMENT if the SCORING ELEMENT enters the open top of the GOAL.*

A SCORING ELEMENT is considered LAUNCHED if it is shot into the air, propelled across the floor to a desired location or in a preferred direction, or thrown in a forceful way.

“Bulldozing” (inadvertent contact with a SCORING ELEMENT while in the path of the ROBOT moving about the FIELD) is not considered LAUNCHING

This is not intended to penalize teams with active manipulators which are expelling SCORING ELEMENTS through normal operation, such as:

- A. Running an intake in reverse causing a SCORING ELEMENT to travel a short distance from the ROBOT.
- B. A ROBOT pushing a SCORING ELEMENT a short distance away in the process of herding it across the FIELD.

G417 ROBOTS only operate GATES as directed. ROBOTS may not:

- A. contact, either directly or transitively through a SCORING ELEMENT, an opposing ALLIANCE’S GATE, or
- B. apply, either directly or transitively through a SCORING ELEMENT, any closing force to either GATE.

Violation: *MAJOR FOUL and the opposing ALLIANCE is awarded the PATTERN RP if [G417.A](#).*

Closing force includes any force applied to the GATE in the direction that closes the GATE, even if the GATE is already closed. A ROBOT bumping into a GATE handle which is stuck open to try to get it to close is not considered a closing force.

G418 ROBOTS may not meddle with ARTIFACTS on RAMPS. ROBOTS may not contact, either directly or transitively through a SCORING ELEMENT CONTROLLED by the ROBOT, ARTIFACTS on a RAMP, including their own RAMP. Additionally, ROBOTS may not:

- A. remove an ARTIFACT from their own RAMP except by operating the GATE, or
- B. remove an ARTIFACT from the opponent’s RAMP by any means.

Violation: *MAJOR FOUL per ARTIFACT, and the ALLIANCE is ineligible for the PATTERN RP if [G418.A](#), or the opposing ALLIANCE is awarded the PATTERN RP if [G418.B](#).*

Exceptions are granted for inconsequential and inadvertent contact made by a ROBOT while operating a GATE.

Example 1: A red ROBOT that contacts an ARTIFACT on the blue RAMP is in violation of this rule and is assessed 1 MAJOR FOUL under [G418](#).

Example 2: A red ROBOT that LAUNCHES an ARTIFACT at an ARTIFACT on the red RAMP, removing it from the RAMP is in violation of this rule. The red ALLIANCE is assessed 1 MAJOR FOUL and is ineligible for the PATTERN RP under [G418.A](#).

Example 3: A red ROBOT contacts and opens the blue GATE, causing 5 ARTIFACTS that were on the blue RAMP to leave the RAMP and return to the FIELD. Red is assessed a total of 6 MAJOR FOULS – 1 under G417.A and 5 under G418.B – in addition to blue being awarded PATTERN RP under G417.A/G418.B.

G419 ROBOTS LAUNCH into their own GOAL. ROBOTS may not:

- A. intentionally place or LAUNCH ARTIFACTS directly onto their own RAMP, or
- B. place or LAUNCH ARTIFACTS into the opponent's GOAL or onto the opponent's RAMP.

Violation: MAJOR FOUL per ARTIFACT and the opposing ALLIANCE is awarded the PATTERN RP if [G419.B](#).

The intent is for ROBOTS to score by LAUNCHING into the open top of their own GOAL. Attempts to intentionally score points with actions that enter the ARTIFACT further down on the RAMP are considered violations of this rule.

Attempts to score points for the opponent either through the opponent GOAL or with actions that enter an ARTIFACT further down on the opponent RAMP are also considered violations of this rule.

There is no violation for scoring in an opponent's DEPOT.

11.4.5 Opponent Interaction

Note, [G420](#) and [G421](#) are mutually exclusive. A single ROBOT to ROBOT interaction which violates more than 1 of these rules results in the most punitive penalty, and only the most punitive penalty, being assessed.

G420 *This is not combat robotics. A ROBOT may not deliberately functionally impair an opponent ROBOT. Damage or functional impairment because of contact with a tipped-over or DISABLED opponent ROBOT, which is not perceived by a REFEREE to be deliberate, is not a violation of this rule.

Violation: MAJOR FOUL and YELLOW CARD. MAJOR FOUL and RED CARD if opponent ROBOT is unable to drive.

FIRST Tech Challenge can be a high-contact competition and may include rigorous gameplay. While this rule aims to limit severe damage to ROBOTS, teams should design their ROBOTS to be robust. Teams are expected to act responsibly.

An example of a violation of this rule includes, but is not limited to:

- A. A ROBOT high-speed rams and/or REPEATEDLY smashes an opponent ROBOT and causes damage. The REFEREE infers that the ROBOT was deliberately trying to damage the opponent's ROBOT.

Examples of functionally impairing another ROBOT include, but are not limited to:

- B. disconnecting wires for operation of a component inside the ROBOT CHASSIS.
- C. disconnecting the opponent ROBOT'S battery (this example also clearly results in a RED CARD because the ROBOT is no longer able to drive).
- D. powering off an opponent's ROBOT using their reasonably well-protected power switch (This example also clearly results in a RED CARD because the ROBOT is no longer able to drive).

Teams should mount their main power switch so it is protected per [R609](#). A team that mounts their ROBOT'S power switch in an exposed location puts themselves at high risk of incidental contact. Powering off an opponent's ROBOT by their exposed power switch during normal interactive gameplay will be considered incidental and not deliberate.

At the conclusion of the MATCH, the Head REFEREE may elect to visually inspect a ROBOT to confirm violations of this rule made during a MATCH and remove the violation if the damage cannot be verified.

"Unable to drive" means that because of the incident, the DRIVER can no longer drive to a desired location in a reasonable time (generally). For example, if a ROBOT can only move in circles, or can only move extremely slowly, the ROBOT is considered unable to drive.

G421 *Do not tip or entangle. A ROBOT may not deliberately, as perceived by a REFEREE, attach to, tip, or entangle an opponent ROBOT.

Violation: MAJOR FOUL and YELLOW CARD. MAJOR FOUL and RED CARD if CONTINUOUS or opponent ROBOT is unable to drive.

Examples of violations of this rule include, but are not limited to:

- A. using a wedge-like MECHANISM to tip over an opponent ROBOT
- B. making frame-to-frame contact with an opponent ROBOT that is attempting to right itself after previously falling over and causing them to fall over.
- C. causing an opponent ROBOT to tip over by contacting the ROBOT after it starts to tip if, in the judgement of the REFEREE, that contact could have been avoided.

Tipping as an unintended consequence of normal ROBOT-to-ROBOT interaction, including single frame-to-frame hits that result in a ROBOT tipping, as perceived by the REFEREE, is not a violation of this rule.

"Unable to drive" means that because of the incident, the DRIVER can no longer drive to a desired location in a reasonable time (generally). For example, if a ROBOT can only move in circles, or can only move extremely slowly, the ROBOT is considered unable to drive.

G422 *There is a 3-count on PINS. A ROBOT may not PIN an opponent's ROBOT for more than 3 seconds. A ROBOT is PINNING if it is preventing the movement of an opponent ROBOT by contact, either direct or transitive (such as against a FIELD element) and the opponent ROBOT is attempting to move. A PIN count ends once any of the following criteria below are met:

- A. the ROBOTS have separated by at least 2 ft. (~61 cm) from each other for more than 3 seconds,
- B. either ROBOT has moved 2 ft. from where the PIN initiated for more than 3 seconds, or
- C. the PINNING ROBOT gets PINNED.

For criteria A, the PIN count pauses once ROBOTS are separated by 2 ft. until either the PIN ends or the PINNING ROBOT moves back within 2 ft., at which point the PIN count is resumed.

For criteria B, the PIN count pauses once either ROBOT has moved 2ft from where the PIN initiated until the PIN ends or until both ROBOTS move back within 2ft., at which point the PIN count is resumed.

Violation: MINOR FOUL and an additional MINOR FOUL for every 3 seconds in which the situation is not corrected.

G423 *Do not use strategies intended to shut down major parts of gameplay. A ROBOT or ROBOTS may not, in the judgment of a REFEREE, isolate or close off any major element of MATCH play for a greater-than-MOMENTARY duration.

Violation: MINOR FOUL and an additional MINOR FOUL for every 3 seconds in which the situation is not corrected.

Examples of violations of this rule include, but are not limited to:

- A. shutting down access to all SCORING ELEMENTS,
- B. quarantining an opponent to a small area of the FIELD,
- C. quarantining SCORING ELEMENTS out of the opposing ALLIANCE'S reach, or
- D. completely blocking access to the opponent's GATE.

G424 GATE ZONE is OFF LIMITS. A ROBOT may not contact, directly or transitively through a SCORING ELEMENT, an opponent ROBOT if either ROBOT is in the opponent's GATE ZONE, regardless of who initiates contact. Exceptions:

- A. A ROBOT in their own ALLIANCE'S GATE ZONE and in their opponent's SECRET TUNNEL ZONE is not protected under [G424](#).

Violation: MINOR FOUL.

For the exception in [G424.A](#), [G425](#) would apply instead.

Figure 11-2 shows some examples of typically protected and non-protected contact in the GATE ZONE. The intent of this rule is to ensure an ALLIANCE has

access to their own GATE. Some of the actions shown below may also fall under other penalties including [G423](#) or escalate to [G211](#).

Figure 11-2: [G424](#) Examples

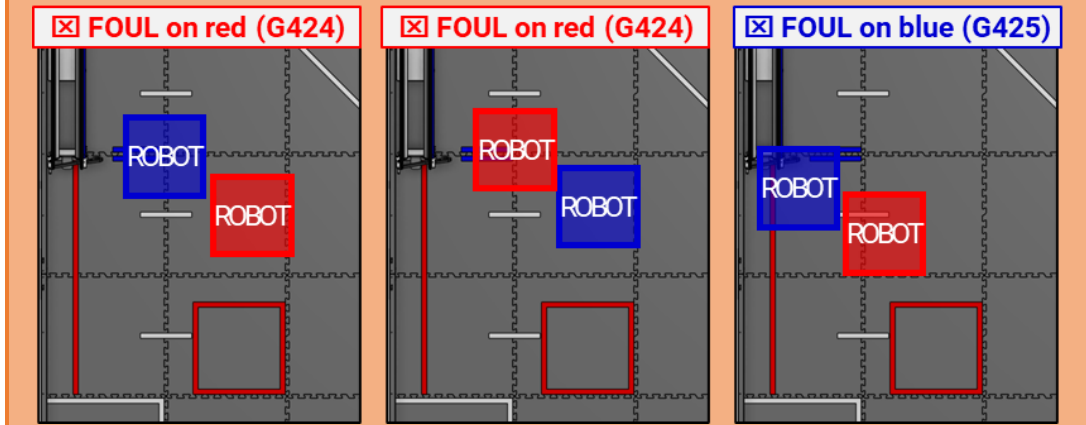

G425 **Keep out of opponent's SECRET TUNNEL** A ROBOT in the opponent's SECRET TUNNEL ZONE may not contact, directly or transitively through a SCORING ELEMENT, an opponent ROBOT regardless of who initiates contact.

Violation: *MINOR FOUL*.

Figure 11-3 shows some examples of typically protected and non-protected contact in the SECRET TUNNEL ZONE. The intent of this rule is to ensure an ALLIANCE has access to ARTIFACTS exiting from the opponent's GATE, but still allow the opponent the opportunity to also access ARTIFACTS if there is no defender present.

Figure 11-3: [G425](#) Examples

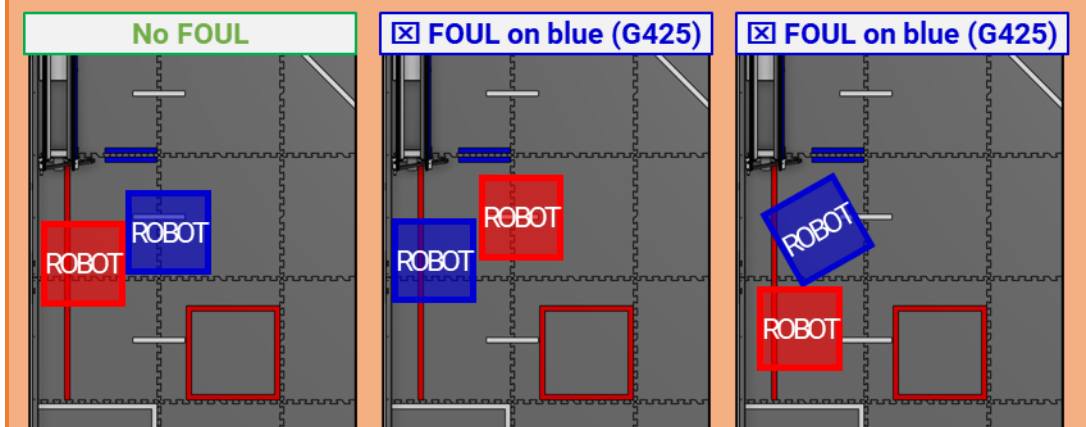

G426 **LOADING ZONE protection.** A ROBOT may not contact, directly or transitively through a SCORING ELEMENT, an opponent ROBOT while either ROBOT is in the opponent's LOADING ZONE, regardless of who initiates contact.

Violation: *MINOR FOUL*.

Figure 11-4 shows some examples of typically protected and non-protected contact in the LOADING ZONE. The intent of this rule is to ensure an ALLIANCE has access to ARTIFACTS exiting from the opponent's GATE but still allows the opponent the opportunity to also access ARTIFACTS if there is no defender present.

Some of the actions shown below may also fall under other penalties including [G423](#).

Figure 11-4: [G426](#) Examples (before the last 20 seconds of the match)

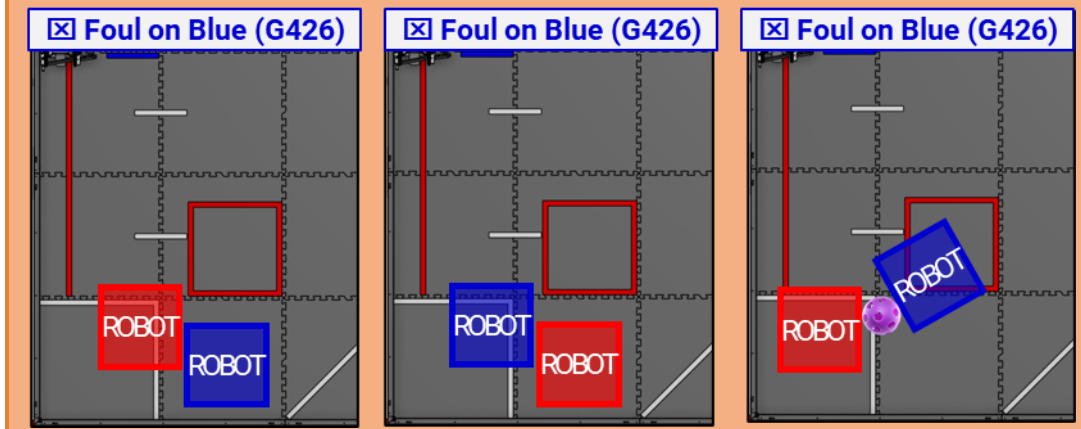

G427 BASE ZONE protection. During the last 20 seconds of the MATCH, a ROBOT may not contact, directly or transitively through a SCORING ELEMENT, an opponent ROBOT while either ROBOT is in the opponent's BASE ZONE, regardless of who initiates contact.

Violation: MAJOR FOUL and opponent ROBOT and any ROBOT fully supported by the contacted ROBOT are awarded fully returned to BASE points.

11.4.6 Human

G428 *No wandering. DRIVE TEAM members must remain in their designated ALLIANCE AREA.

- A. DRIVE TEAMS may be anywhere in their respective ALLIANCE AREA during a MATCH.
- B. DRIVE TEAM members must be staged inside their respective ALLIANCE AREA prior to MATCH start.

Violation: VERBAL WARNING. MINOR FOUL if subsequent violations occur during the event.

The intent of this rule is to prevent DRIVE TEAM members from leaving their assigned AREA during a MATCH to gain a competitive advantage. For example, moving to another part of the FIELD for better viewing or reaching into the FIELD. Simply breaking the plane of the AREA during normal MATCH play is not a FOUL.

DRIVE TEAM members may retrieve SCORING ELEMENTS that have left the FIELD if they are able to do so without violating [G428](#), [G430](#), and [G434](#).

Reintroduction of SCORING ELEMENTS must follow rule [G432](#).

Exceptions are granted in cases concerning safety and for actions that are inadvertent, **MOMENTARY**, and inconsequential.

G429 *DRIVE COACHES and other teams: hands off the controls. A ROBOT shall be operated only by the DRIVERS of that team; DRIVE COACHES may not handle the gamepads. DRIVE COACHES, if desired, may help the DRIVERS in the following ways:

- A. holding the DRIVER STATION device,
- B. troubleshooting the DRIVER STATION device,
- C. selecting OpModes on the DRIVER STATION app,
- D. pressing the INIT button on the DRIVER STATION app,
- E. pressing the (▶) start button on the DRIVER STATION app, or
- F. pressing the (■) stop button on the DRIVER STATION app.

Violation: MAJOR FOUL. YELLOW CARD if greater-than-MOMENTARY.

Exceptions may be made before a MATCH for major conflicts, e.g., religious holidays, major testing, transportation issues.

G430 *DRIVE COACHES, SCORING ELEMENTS are off limits. DRIVE COACHES may not contact SCORING ELEMENTS, unless for safety purposes.

Violation: MINOR FOUL.

G431 *DRIVE TEAMS, watch your reach. Once a MATCH starts, a DRIVE TEAM member inside the FIELD may not:

- A. directly contact a ROBOT,
- B. contact a SCORING ELEMENT in contact with a ROBOT,
- C. disrupt SCORING ELEMENT scoring, or
- D. contact a FIELD element.

Violation: MAJOR FOUL plus YELLOW CARD if [G431.A](#). RED CARD and the opposing ALLIANCE is awarded the PATTERN RP if [G431.C](#).

Exceptions are granted in cases concerning safety and for actions that are inadvertent, **MOMENTARY**, and inconsequential.

For [G431.A](#) and [G431.B](#), the penalty is applied to the DRIVE TEAM member regardless of whether the DRIVE TEAM member or ROBOT initiates contact.

Impacting ARTIFACT scoring includes, but is not limited to:

- A. Contacting an ARTIFACT LAUNCHED by the opponent within the FIELD
- B. Contacting an ARTIFACT in the opponent's GOAL
- C. Disrupting the scoring of an ARTIFACT on the opponent's RAMP or by operating the opponent's GATE

G432 Humans, only meddle with ARTIFACTS in the LOADING ZONE. DRIVE TEAM members may only introduce ARTIFACTS to, remove ARTIFACTS from, or move ARTIFACTS within the LOADING ZONE and only the LOADING ZONE. Actions must occur:

- A. only during TELEOP,
- B. without using a tool,
- C. without causing an ARTIFACT to enter into the LOADING ZONE from elsewhere on the FIELD, and
- D. without causing an ARTIFACT to leave the LOADING ZONE and enter the rest of the FIELD unless the ARTIFACT is CONTROLLED by a ROBOT as follows:
 - i. ARTIFACT CONTROL begins when the ROBOT is in the LOADING ZONE, and
 - ii. ARTIFACT is still CONTROLLED by the ROBOT when the ROBOT leaves the LOADING ZONE.

Violation: MINOR FOUL per ARTIFACT. MAJOR FOUL per ARTIFACT that enters the open top of the GOAL.

DRIVE TEAM members may load SCORING ELEMENTS into a ROBOT that is partially or fully in the LOADING ZONE.

ARTIFACTS that are unintentionally deflected, e.g., a DRIVE TEAM member protecting themselves from a LAUNCHED ARTIFACT, are an exception to this rule.

DECODE is a fast-paced game and teams should practice coordination and communication between the DRIVE TEAM members to avoid unintentional contact between the ROBOT and any humans in violation of [G431.A](#).

G433 Humans may only enter SCORING ELEMENTS. DRIVE TEAM members may only enter ARTIFACTS onto the FIELD.

Violation: MINOR FOUL per non-ARTIFACT item entered onto the FIELD.

G434 The ALLIANCE AREA has a storage limit. During TELEOP, each ALLIANCE may not store more than 6 ARTIFACTS out of play. DRIVE TEAM members making a good-faith effort to immediately enter additional ARTIFACTS back into play is an exception to this rule.

Violation: MINOR FOUL per ARTIFACT over the limit and an additional MINOR FOUL per ARTIFACT over the limit for every 3 seconds in which the situation is not corrected.

The intent of this rule is to prevent an ALLIANCE from starving the FIELD of ARTIFACTS during TELEOP.

Examples of “out of play” include, but are not limited to:

- A. A DRIVE TEAM member holding an ARTIFACT inside or outside of the FIELD
- B. DRIVE TEAM member storing an ARTIFACT outside the FIELD

During AUTO and transition, this rule is not enforced. Upon the start of TELEOP, DRIVE TEAM members must make a good-faith effort to immediately enter ARTIFACTS into the FIELD until compliant with [G434](#).

Teams will not be in violation of this rule if FIELD STAFF return ARTIFACTS to the DRIVE TEAM that have left the FIELD per section [10.8 Other Logistics](#) such that the ALLIANCE holds a number of ARTIFACTS over the limit. However, if the DRIVE TEAM does not then make a good-faith effort to immediately enter ARTIFACTS into the FIELD until compliant with [G434](#), they will be in violation of this rule.

DRIVE TEAM members must keep ARTIFACTS accessible. DRIVE TEAM members intentionally losing access to ARTIFACTS, e.g., by purposefully removing them from the FIELD and ALLIANCE AREA, will be considered egregious behavior and handled per [G211](#).

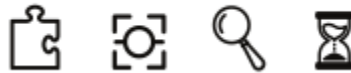

12 ROBOT Construction Rules (R)

The rules listed below explicitly address legal parts and materials and how those parts and materials may be used on a ROBOT. A ROBOT is an electromechanical assembly built by a *FIRST* Tech Challenge team to play the current season's game and includes all the basic systems required to be an active participant in the game –power, communications, control, and movement about the FIELD.

There are many reasons for the structure of the rules, including safety, reliability, parity, creation of a reasonable design challenge, adherence to professional standards, and impact on the competition.

Another intent of these rules is to have all energy sources and active actuation systems on the ROBOT (e.g., batteries, motors, servos, and their controllers) drawn from a well-defined set of options. This is to ensure that all teams have access to the same actuation resources and that the INSPECTORS can accurately and efficiently assess the legality of a given part.

ROBOT construction rules in this section only apply to the construction of your ROBOT as it might be inspected. MATCH play rules and consequences for violating rules during MATCH play are outlined in section [11 Game Rules \(G\)](#).

ROBOTS are made up of COMPONENTS and MECHANISMS.

- A COMPONENT is any part in its most basic configuration, which cannot be disassembled without damaging or destroying the part or altering its fundamental function.
- A MECHANISM is an assembly of COMPONENTS that provide specific functionality on the ROBOT. A MECHANISM can be disassembled (and then reassembled) into individual COMPONENTS without damage to the parts.

Many rules in this section reference Commercial-Off-The-Shelf (COTS) items. A COTS item must be a standard (i.e., not custom order) part commonly available from a VENDOR for all teams for purchase. To be a COTS item, the COMPONENT or MECHANISM must be in an unaltered, unmodified state (with the exception of installation or modification of any software). Items that are no longer commercially available but are functionally equivalent to the original condition as delivered from the VENDOR are considered COTS.

Example 1: A team orders 2 ROBOT panels from RoboPanels Corp. and receives both items. They put 1 in their storeroom and plan to use it later. Into the other, they drill "lightening holes" to reduce weight. The first panel is still classified as a COTS item, but the second panel is now a FABRICATED ITEM, as it has been modified.

Example 2: A team obtains openly available blueprints of a drive module commonly available from Wheels-R-Us Inc. and has local machine shop "We-Make-It, Inc." manufacture a copy of the part for them. The produced part is not a COTS item, because it is not commonly carried as part of the standard stock of We-Make-It, Inc.

Example 3: A team obtains openly available design drawings from a professional publication and uses them to fabricate a gearbox for their ROBOT. The design drawings are considered a COTS item and may be used as "raw material" to

fabricate the gearbox. The finished gearbox itself would be a FABRICATED ITEM, and not a COTS item.

Example 4: A COTS part that has non-functional label markings added would still be considered a COTS part, but a COTS part that has device-specific mounting holes added is a FABRICATED ITEM.

Example 5: A team has a COTS gearbox which has been discontinued. If the COTS gearbox is functionally equivalent to its original condition, it may be used.

A **VENDOR** is a legitimate business source for COTS items that satisfies all the following criteria:

- A. has a Federal Tax Identification number. In cases where the **VENDOR** is outside of the United States, they must possess an equivalent form of registration or license with the government of their home nation that establishes and validates their status as a legitimate business licensed to operate within that country.
- B. is not a “wholly owned subsidiary” of a *FIRST* team or collection of teams. While there may be some individuals affiliated with both a team and the **VENDOR**, the business and activities of the team and **VENDOR** must be completely separable.
- C. should maintain sufficient stock or production capability so they are able to ship any general (i.e., non-*FIRST* unique) product within a timely manner. It is recognized that certain unusual circumstances (such as a global supply chain disruption and/or 1,000 *FIRST* teams all ordering the same part at once from the same **VENDOR**) may cause atypical delays in shipping due to backorders for even the largest **VENDORS**. Such delays due to higher-than-normal order rates are excused. This criterion may not apply to custom-built items from a source that is both a **VENDOR** and a fabricator.

For example, a **VENDOR** may sell flexible belting that the team wishes to procure to use as treads on their drive system. The **VENDOR** cuts the belting to a custom length from standard shelf stock that is typically available, welds it into a loop to make a tread, and ships it to a team. The fabrication of the tread takes the **VENDOR** 2 weeks. This would be considered a FABRICATED ITEM, and the 2-week ship time is acceptable. Alternately, the team may decide to fabricate the treads themselves. To satisfy this criterion, the **VENDOR** would just have to ship a length of belting from shelf stock (i.e., a COTS item) to the team within 5 business days and leave the welding of the cuts to the team.

- D. makes their products available to all *FIRST* Tech Challenge teams. A **VENDOR** must not limit supply or make a product available to just a limited number of *FIRST* Tech Challenge teams.

The intent of this definition is to be as inclusive as possible to permit access to all legitimate sources, while preventing ad hoc organizations from providing special-purpose products to a limited subset of teams in an attempt to circumvent any applicable cost accounting rules.

FIRST desires to permit teams to have the broadest choice of legitimate sources possible, and to obtain COTS items from the sources that provide them with the best prices and level of service available. Teams also need to protect against

long delays in availability of parts that will impact their ability to complete their ROBOT. The build season is brief, so the VENDOR must be able to get their product, particularly *FIRST* unique items, to a team in a timely manner.

Ideally, chosen VENDORS should have effective distribution channels. Remember, *FIRST* Tech Challenge events are not always near home – when parts fail, local access to replacement materials is often critical.

A FABRICATED ITEM is any COMPONENT or MECHANISM that has been altered, built, cast, constructed, concocted, created, cut, heat treated, machined, manufactured, modified, painted, produced, surface coated, or conjured partially or completely into the final form in which it will be used on the ROBOT.

Note that it is possible for an item (typically raw materials) to be neither COTS nor a FABRICATED ITEM. For example, a 20 ft. (~610 cm) length of aluminum which has been cut into 5 ft. (~152 cm) pieces by the team for storage or transport is neither COTS (it is not in the state received from the VENDOR), nor a FABRICATED ITEM (the cuts were not made to advance the part towards its final form on the ROBOT).

Teams may be asked to provide documentation (i.e., reference the relevant rule in this manual) proving the legality of items during inspection where a rule specifies limits for a legal part (e.g., motors, servos, current limits, COTS electronics).

Some of these rules make use of English unit requirements for parts. If your team has a question about a metric-equivalent part's legality, please e-mail your question to customerservice@firstinspires.org for an official ruling. This process should also be employed to seek approval for alternate parts/devices for inclusion in future *FIRST* Tech Challenge seasons.

FIRST Tech Challenge can be a high-contact competition and may include rigorous gameplay. While the rules aim to limit severe damage to ROBOTS, teams should design their ROBOTS to be robust.

12.1 General ROBOT Design

R101 ***STARTING CONFIGURATION is limited to an 18-inch Cube.** In the STARTING CONFIGURATION (the physical configuration in which a ROBOT starts a MATCH), the ROBOT must be fully self-contained within an 18 in. (45.70 cm) wide, by 18 in. (45.70 cm) long, by 18 in. (45.70 cm) high volume. The only exception is that:

- A. pre-loaded SCORING ELEMENTS may extend outside the starting size constraint.

If a ROBOT uses interchangeable MECHANISMS per [I304](#), teams should be prepared to show compliance with this rule and [R105](#) in all configurations.

R102 ***ROBOTS may assist in holding the STARTING CONFIGURATION.** In the STARTING CONFIGURATION, ROBOTS must be fully self-supported (i.e., does not exert force on the sides or top of a sizing tool). ROBOTS may accomplish this using any combination of:

- A. mechanical means while powered-off, and/or

- B. initializing an OpMode that pre-positions servos and motors to a desired stationary position. OpMode may control motors and servos to hold their position to maintain the STARTING CONFIGURATION.

ROBOTS holding STARTING CONFIGURATION during inspection or waiting for a MATCH to start may have to do so for several minutes and should limit the possibility of thermal failure (e.g., not having motors stalled against a hard stop). Teams must also be especially cautious when operating a running ROBOT during inspection, notifying the INSPECTOR that the ROBOT is live and taking every precaution to ensure the process is carried out safely.

- R103** ***There is no ROBOT weight limit.** There is no explicit weight limit for *FIRST* Tech Challenge ROBOTS.

While there is no official weight limit, teams should still consider the impact of a ROBOT'S weight on various factors, including but not limited to:

- FIELD TILE damage
- battery consumption
- ROBOT transportation
- total ROBOT performance

- R104** ***Keep it together.** ROBOTS may not be designed to intentionally detach COMPONENTS.

Violations of this rule during a MATCH will be handled by [G209](#).

R105 **There are expansion limits.** After the MATCH has started, ROBOTS may expand beyond the STARTING CONFIGURATION but are still subject to sizing constraints relative to the ROBOT, based on the initial STARTING CONFIGURATION. The sizing constraints are:

- A. After the start of the MATCH, ROBOTS may expand horizontally but must remain within a fixed 18 in. (45.70 cm) by 18 in. (45.70 cm) when fully expanded per [G414](#). ROBOTS must be physically constrained to fit within these horizontal limits without the use of software.
- B. After the start of the MATCH, ROBOTS may expand vertically up to 18 in. (45.70 cm). ROBOTS may be physically constrained or software limited to fit within this vertical limit.
- C. Within the limitations per [G415](#), ROBOTS may expand vertically up to 38 in. (96.50 cm). ROBOTS may be physically constrained or software limited to fit within this vertical limit.

Figure 12-1: Horizontal Expansion Limit

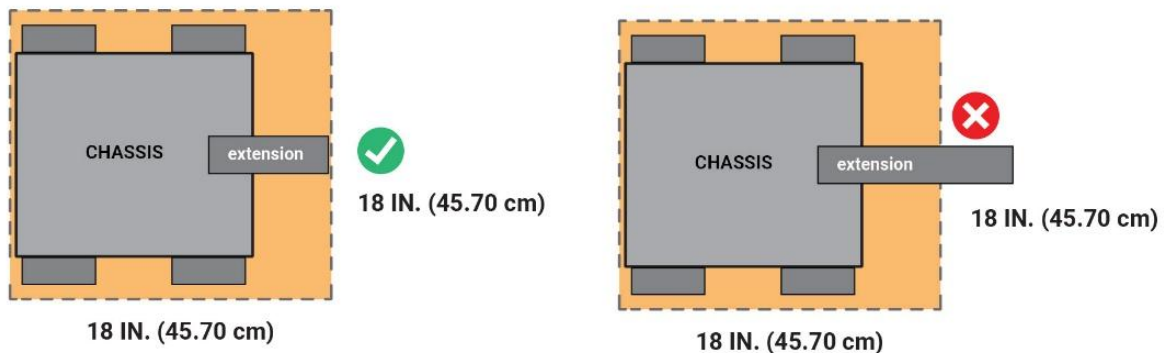
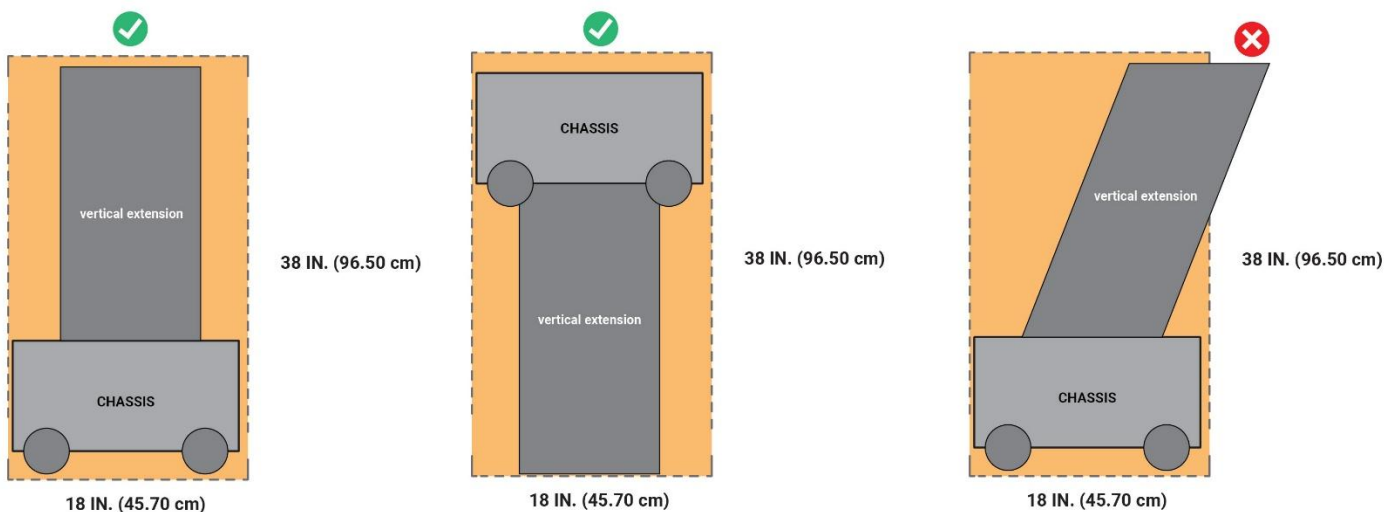

Figure 12-2: Vertical Expansion Limit Examples



Any extension beyond the maximum expansion limit during ROBOT operation is considered a violation of this rule. This includes flexible extensions (e.g., surgical

tubing flappers, star intakes) that cause the ROBOT to exceed the expansion limit.

Teams should be prepared to show compliance with this rule and demonstrate their ROBOT expansions during the inspection process. During inspection, each team will be asked to show the ROBOT'S STARTING CONFIGURATIONS and additionally its configurations at maximum mechanical (horizontal) extensions and mechanical/software (vertical) extensions. Software limits are not sufficient to demonstrate maximum extensions for horizontal expansion.

ROBOTS must show their maximum mechanical extensions during the inspection process. A ROBOT that can mechanically exceed the horizontal limit would be in violation even if the ROBOT has software limiting the position of the extension during the MATCH.

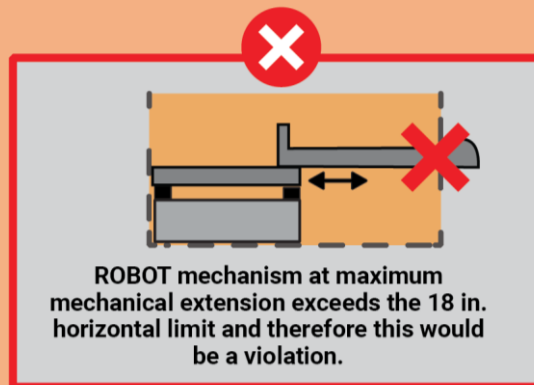

A ROBOT with a single mechanism that can extend out of both sides of a ROBOT would be allowed as long as the overall horizontal dimension at maximum mechanical extension does not exceed 18 in.

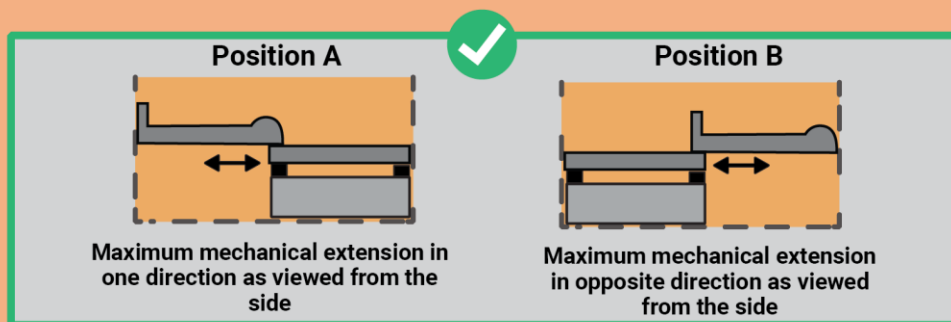

A ROBOT with multiple mechanisms that are not mechanically linked that can extend out of both sides of a ROBOT simultaneously would NOT be allowed if the overall horizontal dimension at maximum mechanical extension exceeds the 18 in. limit.

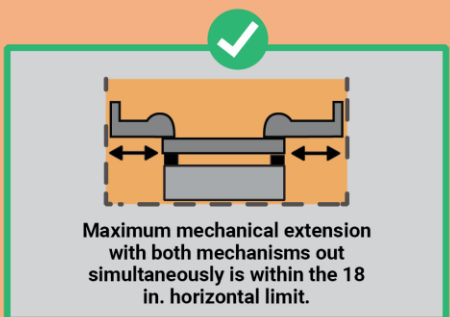

Maximum mechanical extension with both mechanisms out simultaneously is within the 18 in. horizontal limit.

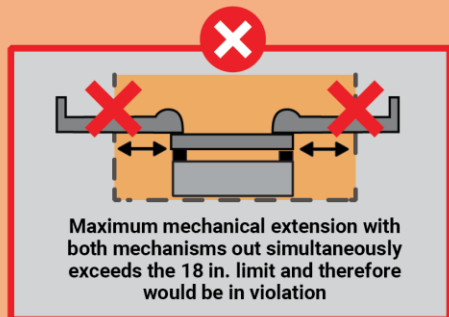

Maximum mechanical extension with both mechanisms out simultaneously exceeds the 18 in. limit and therefore would be in violation

At maximum extension, a ROBOT in compliance will not exceed the maximum allowable vertical extension of 38 in. (96.50 cm) in one direction while maintaining the horizontal expansion requirements of 18 in. (45.70 cm) length and width perpendicular to the vertical height.

Teams are responsible for maintaining compliance with expansion limits and subject to penalties listed in [G414](#) and [G415](#) for any violations during the MATCH.

12.2 ROBOT Safety & Damage Prevention

R201 *Do not damage the TILE floor. Traction devices must not have surface features which are known to damage the TILE floor. Traction devices are all parts of the ROBOT that are designed to transmit any propulsive and/or braking forces between the ROBOT and the FIELD.

Examples of traction devices known to cause damage when used directly on TILE floors are high traction wheels (for example, AndyMark am-2256) and high grip tread (for example, Roughtop, AndyMark am-3309). While these (and other) COMPONENTS are not outright prohibited, e.g., used as part of an intake, MECHANISMS that involve these COMPONENTS contacting the TILE floor are not allowed.

R202 *No exposed sharp edges. Protrusions from the ROBOT and exposed surfaces on the ROBOT shall not pose hazards to the ARENA elements (including SCORING ELEMENTS) or people.

R203 *Design ROBOTS for safety and fair play. ROBOT parts shall not be made from hazardous materials, be unsafe, cause an unsafe condition, or interfere with the operations of other ROBOTS. Examples of items that will violate this rule include (but are not limited to):

- A. shields, curtains, or any other devices or materials solely designed or used to obstruct or limit the vision of any DRIVE TEAM members and/or interfere with their ability to safely control their ROBOT,
- B. speakers, sirens, air horns, or other audio devices that generate sound at a level sufficient to be a distraction,
- C. any devices or decorations specifically intended to jam or interfere with the remote sensing capabilities of another ROBOT, including vision systems, acoustic range finders, sonars, infrared proximity detectors, etc. This includes imagery on your ROBOT that utilizes or closely mimics 36h11 AprilTags,

- D. flammable gasses,
- E. any device intended to produce flames or pyrotechnics,
- F. hydraulic fluids or hydraulic items,
- G. switches or contacts containing liquid mercury,
- H. exposed, untreated hazardous materials (e.g., lead weights) used on the ROBOT. These materials may be permitted if painted, encapsulated, or otherwise sealed to prevent contact. These materials may not be machined in any way at an event,
- I. high intensity light sources used on the ROBOT may only be illuminated for a brief time while targeting and may need to be shrouded to prevent any exposure to participants. Complaints about the use of such light sources will be followed by re-inspection and possible disablement of the device,
- J. animal based materials,
- K. any device designed to damage or flip competing ROBOTS, and
- L. devices or conditions that pose an unnecessary risk of entanglement.

Flashing lights can be particularly distracting and can cause harm to some individuals. Decorative or functional lighting which flashes at greater than 2Hz will invite additional scrutiny and teams may be asked to disable or modify their lighting at the discretion of the Head REFEREE and/or LRI.

R204 ***SCORING ELEMENTS stay with the FIELD.** ROBOTS must allow removal of SCORING ELEMENTS from the ROBOT and the ROBOT from FIELD elements while powered off.

Teams must make sure that SCORING ELEMENTS and ROBOTS can be quickly, simply, and safely removed.

R205 ***Do not make a mess on the FIELD.** ROBOTS may not contain any materials which if unintentionally released would damage the FIELD, other ROBOTS or delay the start of a MATCH due to required clean-up or decontamination. Lubricants may be used only to reduce friction within the ROBOT and must not contaminate the FIELD or other ROBOTS.

Lubricants (e.g., grease) used on the ROBOT must not be excessively applied such that they spin off or drip off during normal ROBOT operations on the FIELD.

Additional examples of items that will violate this rule include (but are not limited to):

- any ballast not secured sufficiently, including loose ballast such as sand, coffee beans, kitty litter, or ball bearings, such that it may be released on the FIELD during a MATCH
- liquid or gel materials
- tire sealant, and
- other lubricants including graphite powder

R206 ***Do not damage SCORING ELEMENTS.** ROBOT elements likely to contact SCORING ELEMENTS shall not pose a significant hazard to the SCORING ELEMENT.

SCORING ELEMENTS are expected to undergo a reasonable amount of wear and tear as they are handled by ROBOTS, such as scratching or marking. Gouging, tearing off pieces, or routinely marking SCORING ELEMENTS are violations of this rule and [G407](#).

R207 *ROBOTS don't use air. ROBOTS are restricted in their use of air in the following ways:

- A. ROBOTS may not use any closed air devices such as but not limited to pneumatic solenoids or cylinders, gas storage vessels, gas springs, compressors, or vacuum generating devices. Air-filled (pneumatic) wheels are exempt from this rule.
- B. ROBOTS may not use any device which creates high-speed airflow, except COTS computing devices manufactured with integrated cooling fans.

Examples of a "device which creates high-speed airflow" include but are not limited to a fan designed to move SCORING ELEMENTS on the FIELD.

High-speed flywheels or rollers used for manipulating SCORING ELEMENTS would not on their own be considered a high-speed airflow device.

R208 *No grabbing the floor. ROBOTS may not use any mechanism which is designed to increase downforce by either grabbing FIELD surfaces or by using some form of generated airflow to provide downward suction.

12.3 Fabrication

R301 *COTS MECHANISMS are legal but have limits. COTS MAJOR MECHANISMS (as defined in [I301](#)) purposefully designed to complete a game task are prohibited. Allowed exceptions to this rule are:

- A. COTS drive CHASSIS, provided none of the individual parts violate any other rules, and
- B. COTS MAJOR MECHANISMS created as part of the official [FIRST Tech Challenge Starterbots](#).

COTS parts are intended to help teams design and build ROBOT MECHANISMS to complete game tasks and solve challenges but are not intended to be purpose-built complete bolt-on out-of-the-box solution to complete game objectives.

R302 *Legal COTS parts and raw materials can be modified. Allowed raw materials and legal COTS parts can be modified (drilled, cut, painted, etc.) as long as no other rules are violated.

Raw materials refers to unfinished building stock such as but not limited to:

- sheet stock
- extruded shapes
- metals, plastic, rubber, and wood
- magnets

R303 *COTS must be single DoF. COTS COMPONENTS and MECHANISMS must not exceed a single degree of mechanical freedom (DoF). Examples of allowed COTS single degree of freedom MECHANISMS and COMPONENTS are as follows:

- A. linear slide kit,
- B. linear actuator kit,
- C. single speed (non-shifting) gearboxes,
- D. pulley,
- E. turntable,
- F. lead screw, and
- G. single DoF gripper.

Allowed exceptions to this rule are:

- H. ratcheting devices (wrenches, bearings, etc.),
- I. holonomic wheels (omni or mecanum),
- J. dead-wheel odometry kits,
- K. items that transfer motion between misaligned COMPONENTS (such as universal joints, flexible shaft couplers, and similar items), and
- L. items that connect structures at variable angles (such as ball joint linkages, rod ends, and similar items).

The intent of this rule also extends to disallow highly specialized individual COMPONENTS only designed to assemble into a multiple DoF COTS COMPONENT.

The general test for a single degree of freedom MECHANISM is whether the orientation and position of each COMPONENT in the MECHANISM can be generally predicted based on the orientation and position of a single COMPONENT (such as the input) of the system.

Example 1: A mecanum drivetrain is made up of 4 independent drive modules, each with a single DoF (ignoring the DoF of the mecanum wheels as allowed by this rule), attached to a common structure (e.g., CHASSIS). The overall MECHANISM is still a single DoF.

Example 2: Dead wheel odometry modules, allowed by this rule, are typically composed of a 1 DoF wheel (ignoring the effect of the holonomic wheel) providing forward/backwards motion and a spring force providing an additional unique rotational or vertical motion, creating a 2 DoF system.

Example 3: Simple gripper claws, comprised of a single actuator moving 2 gripper jaws simultaneously or double actuators each controlling an independent gripper jaw, are by and large a single DoF. However, grippers that incorporate additional actuators providing additional twisting and/or bending actions (like a wrist) add degrees of freedom that are prohibited in COTS MECHANISMS.

-
- R304** *Custom parts can be reused year to year. FABRICATED ITEMS created before Kickoff are permitted.
- R305** *Custom designs and software can be reused year to year. ROBOT software and designs created before Kickoff are permitted.
- R306** *SCORING ELEMENTS are not allowed for ROBOT construction. Current season SCORING ELEMENTS or replicas of SCORING ELEMENTS are not allowed to be used as part of ROBOT construction or for any other team supplied SCORING ELEMENTS.
- R307** *During an event, work can occur outside of pit hours. During an event a team is attending (regardless of whether the team is physically at the event location), the team may work on or practice with their ROBOT or ROBOT elements outside of the hours that pits are open.

For teams who chose to work offsite during an event: please work smartly and safely. Ensure team members get adequate rest and have sufficient adult supervision during afterhours and off-site work.

Note that [E107](#) and [E108](#) impose additional restrictions on work done on the ROBOT or ROBOT materials while attending an event.

12.4 ROBOT SIGN Rules

A ROBOT SIGN is a required assembly which attaches to the ROBOT. A ROBOT SIGN simultaneously identifies a ROBOT'S team number as well as its ALLIANCE affiliation for FIELD STAFF. Criteria used in writing these rules include the following:

- Maximize FIELD STAFF'S ability to determine team number and ALLIANCE of a ROBOT,
- Minimize the amount of design challenge in creating ROBOT SIGNS, and
- Increase consistency in displaying ROBOT identification.

R401 *Two ROBOT SIGNS per ROBOT. ROBOT SIGNS must be placed in at least 2 separate locations on the ROBOT. These locations must be on opposite or adjacent surfaces of the ROBOT, ≥ 90 degrees apart. All ROBOT surfaces visible to FIELD STAFF can be used for placing ROBOT SIGNS including the top of the ROBOT. ROBOT SIGNS must meet the following criteria:

- A. be made of a robust material,
- B. minimally be 6.5 inches (16.5 cm) wide,
- C. minimally be 2.5 inches (6.4 cm) tall (Figure 12-3), and
- D. be supported by the structure/frame of the ROBOT.

The intent of this rule is for FIELD STAFF to easily view ROBOT SIGNS from at least 12 feet (3.65 meters) away before, during, and after the MATCH.

Examples of robust materials that satisfy this rule include, but are not limited to, acrylic, plastic laminated paper, wood, and metal. ROBOT SIGNS must be designed to withstand vigorous game play.

Figure 12-3: Team Number ROBOT SIGN Sizing

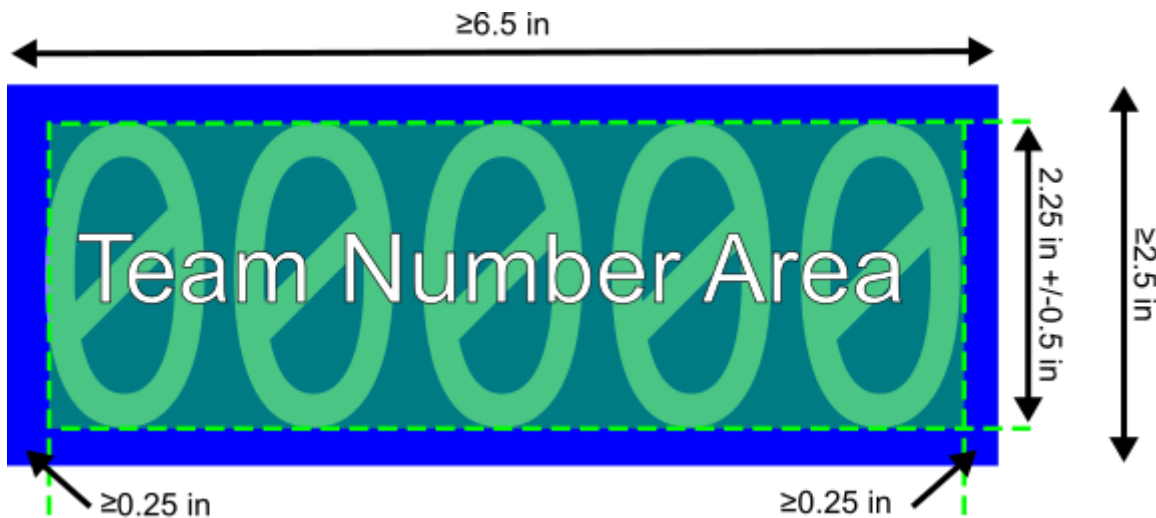

R402 *ROBOT SIGNS indicate your ALLIANCE. Each ROBOT SIGN must contain a rectangle with a solid red or blue opaque background at least 6.5 in. by 2.5 in. (16.50 cm by 6.35 cm) in size to indicate their ALLIANCE color (Figure 12-3), as assigned in the MATCH schedule at the event. Visible markings on ROBOT SIGNS when installed on the ROBOT, other than the following, are prohibited:

- A. those required per [R403](#),
- B. solid white *FIRST* logos no larger than 1.5 in. (3.80 cm) in height (Figure 12-5),
- C. small amounts of hook-and-loop tape, hard fasteners, or functional equivalents,
- D. narrow areas of differing colors exposed at corners, folds, or cutouts,
- E. dark narrow markings on background solely for template purposes, and
- F. cannot be powered or rely on power from any sources to illuminate/reveal ALLIANCE color.

ROBOT SIGNS that are reversible or configurable must not allow the opposite ALLIANCE color to be visible to FIELD STAFF, except where permitted by this rule.

Figure 12-4: Minimum sized ALLIANCE rectangle

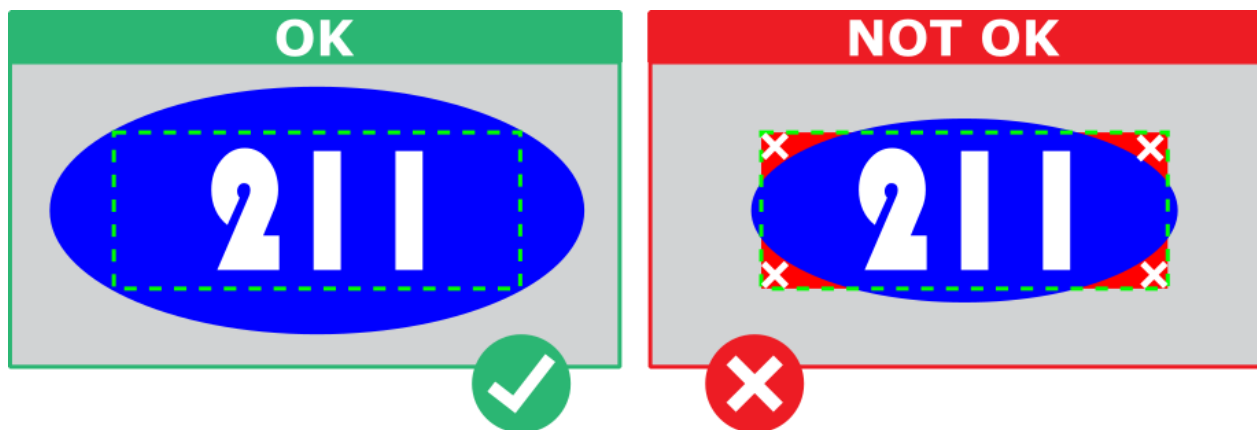

Figure 12-5: Legal team number display for team 117 playing on the red ALLIANCE



R403 *Team number on ROBOT SIGNS. Team numbers must be displayed and positioned on the ROBOT SIGN as shown in Figure 12-3, Figure 12-6, and Figure 12-7 and meet the following additional criteria:

- A. consist of solid opaque white Arabic numbers (e.g., 1,2,3,4) which are 2.25 in. +/-0.5 in. (5.70 cm +/- 1.25 cm) tall,
- B. there must be a minimum of 0.25 in. (0.60 cm) of background surrounding the numbers,
- C. numbers may not be vertically stacked (Figure 12-7),
- D. be made of robust materials, and
- E. cannot be powered or rely on power from any sources to illuminate/reveal numbers.

Figure 12-6: Legal number for team 21001 playing on the blue ALLIANCE



Figure 12-7: Team number orientation examples for team 1355 playing on the blue ALLIANCE

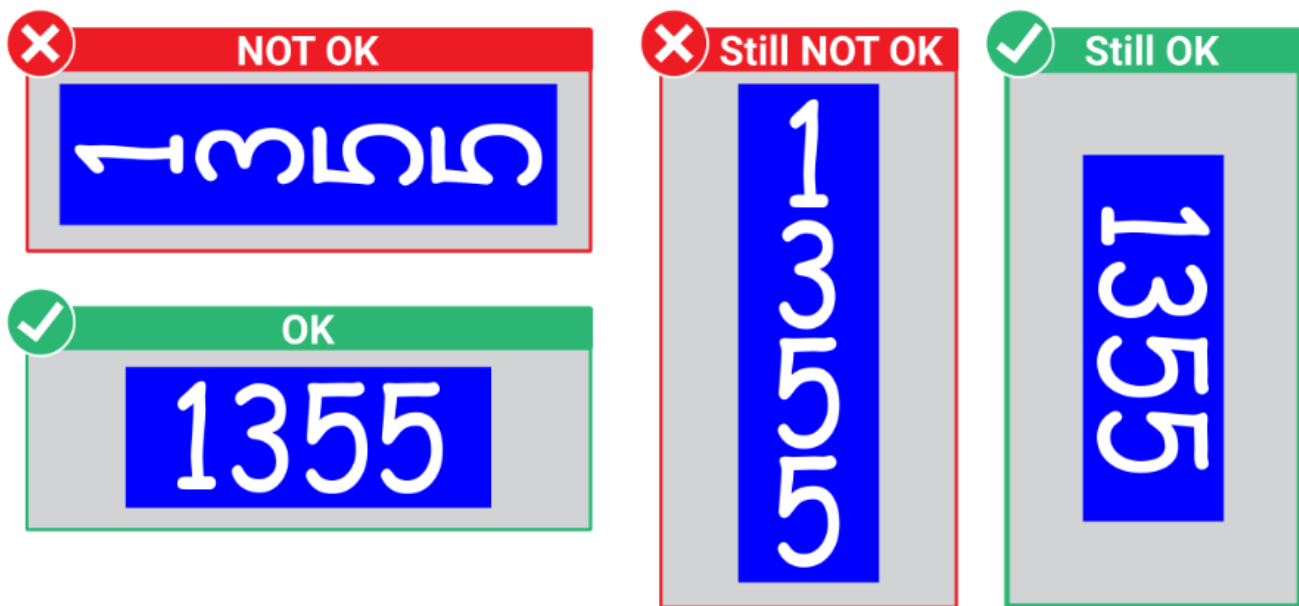

If a team at an event does not have completely legal ROBOT SIGNS, and there is no color printer or other means available at the event to create a legal ROBOT SIGN, the Head REFEREE may approve an alternate substitute for use at the event.

Team numbers must be robust enough to withstand the rigors of MATCH play. Example robust materials include:

- self-adhesive numbers (mailbox or vinyl numbers)
- ink jet or laser printed numbers on paper and laminated or protected from ROBOT-to-ROBOT interaction.

Examples of prohibited team numbers on ROBOT SIGNS include but are not limited to:

- team numbers only visible by edge lit engraved plastic
- LED Display numbers

12.5 Motors & Actuators

R501 *Allowable motors. The only allowed motor actuators are:

Table 12-1: Motor allowances

Motor Name	Part Numbers Available	Notes
AndyMark NeveRest 12V DC	am-3104, am-3104b	
AndyMark NeveRest Hex 12V DC	am-3104c	
goBILDA Yellow Jacket 520x Series 12V DC	5201-0002-0026, etc.	5201, 5202, 5203, and 5204 series
goBILDA 5000 Series 12V DC	5000-0002-4008, etc.	
Modern Robotics / MATRIX 12V DC	5000-0002-0001	Discontinued
NFR Products Yuksel 12V DC	NFR-600-100-000	
REV Robotics HD Hex 12V DC	REV-41-1291	
REV Robotics Core Hex 12V DC	REV-41-1300	
Studica Robotics Maverick 12V DC	75001	
SWYFT Robotics SWYFT Spike Motor	SR-MOTOR-DC-01	
TETRIX MAX 12V DC	739530, 39530	Discontinued
TETRIX MAX TorqueNADO 12V DC	W44260	
Factory installed vibration and autofocus motors resident in COTS computing devices (e.g., rumble motor in a smartphone); can only be used as part of the device and cannot be removed and/or repurposed. These motors do not count toward the limit in R503.		
Motors integral to a COTS sensor (e.g., LIDAR, scanning sonar), provided the device is not modified except to facilitate mounting. These motors do not count toward the limit in R503.		

Additional motors may be added to the legal motor list in future competition manual updates.

Many legal gearmotors are sold with labeling based on the entire assembly. These motors may be used with or without the provided gearbox, and/or with any other compatible gearbox.

R502 *Allowable servos. Servo actuators must meet the requirements below. Servos must be compatible with the power regulation devices they are ultimately used with (per [R505](#)) and may include additional servo position output interfaces (e.g., 4th Wire Position Feedback).

Table 12-2: Servo Requirements at 6V

Actuator Class	Mechanical Output Power	Stall Current	Example Servos (including, but not limited to)
Servo	≤ 8 watts @6V	≤ 4 amps @6V	AndyMark High-Torque Servos (am-4954)
			Axon MAX+ Servo (Axon MAX+)
			DSSERVO 35KG Coreless (DS3235MG)
			FEETECH Digital Servo (FT5335M-FB)
			goBILDA Dual Mode Servo (2000-0025-0003)
			REV Robotics Smart Servo (REV-41-1097)
Linear Servo	N/A	≤ 1 amps @6V	Studica Multi-Mode Smart Servo (75002)
			Actuonix Micro Linear Servo (P8-100-252-12-R)
			Hitec Linear Servo (HLS12-3050-6V)
			Studica Linear Servo RC Actuator (75014)

[Servo mechanical output power](#) is approximated by the following formula (using 6V data reported by manufacturer):

- **Mechanical Output Power = 0.25 x (Stall Torque in N-m) x (No Load Speed in rad/s)**

Servos must meet both requirements to be legal for use. Refer to the [Inspection Quick Reference](#) document for a list of servos that are pre-approved, otherwise teams must be able to provide documentation verifying servo specifications. Use the [online calculator](#) to verify output power compliance.

If a manufacturer does not provide 6V specs, any specs for voltages that exceed 6V are allowed to be used.

Stall current is the maximum stall current possible for the device at the specified voltage, regardless of any user or VENDOR adjustable software limits that may be available within the servo.

It is important to ensure the voltage provided by the intended power regulation device is within the operating voltage range of the desired servo. The REV Control Hub and REV Expansion Hub provide 5V to servos, and the goBILDA Servo Power Injector, REV Servo Power Module, Studica Servo Power Block, and REV Servo Hub provide 6V to servos. While virtually all servos are compatible with 6V, servos with an operating voltage range of 6-8.4 DCV, for example, may not work properly when only provided 5V.

R503 ***ROBOTS are limited to a total of 8 motors and 10 servos.** A ROBOT may not have more than 8 motors and 10 servos from the allowable actuator lists per [R501](#) and [R502](#) for all MECHANISMS used in all configurations.

If a ROBOT has multiple configurations used at a single event which use different MECHANISMS, the sum total of all motors and servos must be less than or equal to the limit set in this rule.

For servos, note that each REV Expansion Hub and REV Control Hub provide 5V and are limited to a max current output of 5A total shared across all servo ports and the +5V auxiliary power port, with a 2A maximum limit across paired servo ports (10W of maximum electrical output power per port pair, 25W total). Teams should make sure that their total servo power usage always remains below this limit.

Given the extensive number of motors and servos allowed on the ROBOT, teams are encouraged to consider the total power available from the ROBOT battery during the design and build of the ROBOT. Drawing large amounts of current from many motors and/or servos at the same time could lead to drops in ROBOT battery voltage that may result in exceeding the battery fuse limits or browning out the control system leading to power loss or communications loss.

R504 ***Do not modify actuators unless explicitly allowed.** The integral mechanical and electrical system of any motor or servo must not be modified. Motors and servos used on the ROBOT shall not be modified in any way, except as follows:

- A. the mounting brackets and/or output shaft/interface (including pinion gears) may be modified to facilitate the physical connection of the motor to the ROBOT and actuated part,
- B. the electrical leads may be trimmed to length as necessary and connectors or splices to additional wiring may be added (per [R503](#)), and purely electrical enclosures can be substituted with functionally equivalent replacements,
- C. servos may be modified as specified by the manufacturer (e.g., re-programming or modification for continuous rotation),
- D. minimal labeling may be applied to indicate device purpose, connectivity, functional performance, etc. as long as the team applied label does not obstruct the markings used to identify the device,
- E. insulation may be applied to electrical terminals,
- F. repairs, provided the original performance and specifications are unchanged, and
- G. maintenance recommended by the manufacturer.

R505 ***All actuators must be controlled and powered through approved devices.** With the exception of servos, fans, or motors integral to sensors of COTS computing devices permitted in [R501](#), all actuator control signals must originate from a power regulating device. The only power regulating devices for actuators permitted on the ROBOT are:

Table 12-3: Power Regulators and Limits

Power Regulating Device	Part Number	Load Limit per Device
goBILDA 6V Servo Power Injector	3125-0001-0001	2 Servos per Port
REV Control Hub or Expansion Hub Motor Ports	REV-31-1153 / REV-31-1595	2 Motors per Port
REV Control Hub or Expansion Hub Servo Ports	REV-31-1153 / REV-31-1595	2 Servos per Port
REV Servo Power Module	REV-11-1144	2 Servos per Port
REV Robotics Servo Hub	REV-11-1855	2 Servos per Port
REV SPARKmini	REV-31-1230	2 Motors per Device
Studica Servo Power Block	75005	2 Servos per Port

R506 ***No relays or alternative electrical actuation.** The application of electromechanical actuation through the use of additional relays, electromagnets, electrical solenoid actuators, or related systems is prohibited. In addition, the use of relays and electromagnets is also prohibited.

12.6 Power Distribution

In order to maintain safety, the rules in this section apply at all times while at the event, not just while the ROBOT is on the FIELD for MATCHES.

R601 ***Battery limit – everyone has the same main ROBOT power.** The only legal source of electrical energy for the ROBOT control system and actuation during the competition, the ROBOT battery, must be 1 and only 1 approved 12V NiMH main battery. The ROBOT main battery must have a COTS equivalent in-line 20A ATM mini blade fuse installed. Installed connectors may be replaced with other popular connectors such as Anderson Powerpole, XT30, or any connector with a comparable power rating. The only allowed ROBOT main power battery packs are:

Table 12-4: Legal ROBOT Main Power Battery Packs

Battery Pack	Part Number	Notes
AndyMark Flat Pack Battery DC 12V	am-5290	
goBILDA 12V NiMH Nested Battery	3100-0012-0020	
Matrix 12V 3000mAh NiMH	14-0014	May be labeled as “Modern Robotics”
REV 12V Slim Battery	REV-31-1302	

Battery Pack	Part Number	Notes
Studica 12V 3000mAh NiMH	70025	
TETRIX MAX 12V 3000mAh NiMH	W39057	Formerly 739023
WATTOS 12V Battery	WT-NMH1230	

There are many other similar style batteries available from multiple VENDORS, but only the listed manufactures and part numbers are legal for use at *FIRST* Tech Challenge Events.

Batteries should be charged in accordance with manufacturer's specification. (Please see the [FIRST Safety Manual](#) for additional information.)

R602 ***Other batteries are only allowed for peripheral devices and LEDs only.** COTS USB battery packs with a capacity of 100Wh or less (27,000mAh at 3.7V), with 5V/5A max output or 12V/5A max output using USB-PD per port, and batteries integral to a self-contained camera (e.g., GoPro style camera) may be used provided they are:

- A. connected only using unmodified COTS cables,
- B. charged according to manufacturer recommendations,
- C. securely fastened to the ROBOT,
- D. not supplement power to any of the ROBOT actuators, and
- E. not used by any devices receiving control signals from the ROBOT control system (i.e., COTS USB battery packs must remain electrically isolated from the ROBOT power systems.).

Exceptions to part E of this rule are:

- i. powered USB Hubs, and
- ii. ROBOT CONTROLLER smartphones.

For example, a REV Blinkin powered by a COTS USB battery pack cannot be controlled by signals from a REV Control or Expansion Hub. Any device receiving signals from a REV Control or Expansion Hub must be powered by the main ROBOT battery.

R603 ***Charge batteries with safe connectors.** Any battery charger used to charge a ROBOT battery must have a corresponding polarized connector installed.

Batteries must never be charged using alligator clips or similar.

R604 ***Charge batteries at a safe rate.** Any battery charger used to charge a ROBOT battery may not be used such that it exceeds a 3-amp average charge current. Follow all manufacturer recommendations when charging batteries.

R605 ***Batteries are not ballast.** No batteries other than those allowed per [R601](#) and [R602](#) are allowed on the ROBOT, whether or not they are being used to supply power.

For example, teams may not use additional batteries as extra weight on their ROBOTS.

R606 *Batteries should be securely mounted. The ROBOT battery must be secured such that it will not dislodge during vigorous ROBOT interaction including if the ROBOT is turned over or placed in any arbitrary orientation. Batteries must be mounted such that they are protected from direct contact with other ROBOTS or any sharp edges.

R607 *Electrical connections should be robust and must be insulated. All electrical paths may include intermediate elements such as COTS connectors (Anderson Powerpole, XT30, and similar crimp or quick-connect style connectors), splices, COTS flexible/rolling/sliding contacts, and COTS slip rings, as long as the entire electrical pathway is via appropriately gauged/rated elements and all connections are protected from accidental electrical shorts

Teams are strongly encouraged to insulate all exposed electrical terminations or provide physical barricades to protect from accidental electrical shorts.

R608 *Limit non-battery energy. Non-electrical sources of energy used by the ROBOT (i.e., stored at the start of a MATCH) shall come only from the following sources:

- A. a change in the altitude of the ROBOT center of gravity, or
- B. storage achieved by deformation of ROBOT parts including, but not limited to, springs, rubber bands, surgical tubing, etc.

R609 *Connect the ROBOT battery though the Main Power Switch. Exactly one main power switch must control all power provided by the ROBOT battery pack to all power regulating devices on the ROBOT (except as specified by [R602](#)) such that all the following conditions are met:

- A. must be one of the following approved power switches:

Table 12-5: Legal Power Switches

Power Switch	Part Number
AndyMark FTC Power Switch w/ Bracket	am-4969
goBILDA Floodgate Power Switch	3103-0005-0001
REV Switch Cable and Bracket	REV-31-1387
Studica On/Off Power Switch Kit	70182
TETRIX R/C Switch Kit	W39129
WATTOS Power Switch Kit	WTS-SW1220

- B. must be mounted or located where it is accessible to the team and FIELD STAFF
- C. secondary power switches can be used on the 12V line downstream of the main power switch.

There are no specific location requirements for the main power switch, but it should be located clear of any moving parts and other obstructions that would block its access during normal ROBOT operations.

Examples considered not “quickly and safely accessible” include main power switches covered by an access panel or door, or mounted on, underneath or immediately adjacent to moving COMPONENTS.

The main power switch should be mounted on the ROBOT, so it is protected from ROBOT-to-ROBOT contact to avoid inadvertent actuation or damage.

- R610** *Fuse ratings should not be altered. Fuses must not be replaced with fuses of higher rating than originally installed or according to manufacturer's specifications; fuses may not be shorted out. Fuses must not exceed the rating of those closer to the battery. If necessary, a fuse may be replaced with a smaller rating. Replaceable fuses must be single use only; self-resetting fuses (breakers) are not allowed.
- R611** *The ROBOT frame is not a wire. All wiring and electrical devices shall be electrically isolated from the ROBOT frame. The ROBOT frame must not be used to carry electrical current. Electrically grounding the control system electronics to the frame of the ROBOT is only permitted such that all of the following conditions are met:

- A. straps/cables used must be from the following approved parts:

Table 12-6: Legal ROBOT Grounding Straps

Grounding Strap	Part Number
AndyMark Resistive Grounding Strap	am-4648a
REV Resistive Grounding Strap	REV-31-1269
Swyft Grounding Cable	SR-Ground-01

- B. the strap/cable must directly connect to a fully COTS COMPONENT with an XT30 connector, and also must connect directly to the frame of the ROBOT (via the resistive terminal), and
- C. no ROBOT COMPONENTS or MECHANISMS are designed to electrically ground the ROBOT frame to the FIELD.

Compliance with this rule can be checked by unplugging the battery from the ROBOT main power switch assembly and observing a $>120\Omega$ resistance between the (+ / red) input terminal of the ROBOT main power switch assembly in the “ON” position or the (- / black) input terminal of the ROBOT main power switch assembly and any electrically connected point on the ROBOT. Most aluminum has a clear anodizing layer or oxidation layer on it that acts as an insulator. In order to make a good electrical connection with the grounding strap to the frame, it may be necessary to scratch/file/remove the anodize/oxidation layer from the area of contact with the metal first.

Note that some cameras, decorative lights, and sensors (some encoders, some IR sensors, etc.) have grounded enclosures or are manufactured with conductive plastics. These devices must be electrically isolated from the ROBOT frame to ensure compliance with this rule.

Examples of devices with COTS XT30 connectors include but are not limited to the REV Control Hub (REV-31-1595), a COTS XT30 power distribution block (such as a REV-31-1293), or a COTS Anderson Powerpole to XT30 Adapter (such as REV-31-1385). For additional details on installation of the grounding strap, please see the [ROBOT Wiring Guide](#).

R612 *Electrical system must be inspectable. All power regulating devices (per [R505](#)), associated wiring, and all fuses must be visible for inspection.

“Visible for inspection” does not require that the items be visible when the ROBOT is in STARTING CONFIGURATION, provided the team can make the items viewable during the inspection process.

R613 *No high voltage allowed except for LEDs. Any active electrical item that is not an actuator (specified in [R501](#)) or power regulation device (specified in [R505](#)) is considered a CUSTOM CIRCUIT. CUSTOM CIRCUITS shall not provide regulated output voltages exceeding 5V, except if solely used for powering LEDs, but may pass through unregulated battery voltage.

R614 *Energize Power Regulating Devices as specified. All power regulating devices ([R505](#)) must be powered per the manufacturer’s instructions and the following table must be true:

Table 12-7: Power Regulation Device Power Requirements

Power Regulating Device	Part Number	Method of Powering
goBILDA 6V Servo Power Injector	3125-0001-0001	Only powered using the XT30 connectors on the device by the ROBOT main battery
REV Control Hub / REV Expansion Hub	REV-31-1153 / REV-31-1595	Only powered using the XT30 connectors on the device by the ROBOT main battery
REV Servo Power Module	REV-11-1144	Only powered using the screw terminals and must only be powered by the ROBOT main battery
REV Robotics Servo Hub	REV-11-1855	Only powered using the power terminals and must only be powered by the ROBOT main battery
REV SPARKmini	REV-31-1230	Only powered by the Power input and must only be powered by the ROBOT main battery
Studica Servo Power Block	75005	Only powered by JST-VH power connector, and must only be powered by the ROBOT main battery

R615 *Use appropriately sized wire. All circuits shall be wired with appropriately sized insulated copper wire (SIGNAL LEVEL cables do not have to be copper):

Table 12-8: Wire sizing requirements

Application	Minimum Wire Size
12V Main Battery Power	18 AWG
Motor Power (unless otherwise listed)	(19 SWG or 1 mm ²)

Application	Minimum Wire Size
11-20A fuse protected circuit	
Motor Power - TETRIX MAX 12V DC Motors, REV Robotics Core Hex (REV-14-1300)	22 AWG (22 SWG or 0.5 mm ²)
PWM / Servo	
LEDs (5V / 12V)	
≤10A fuse protected circuit	
SIGNAL LEVEL circuits (i.e., circuits which draw ≤1A continuous and have a source incapable of delivering >1A, including but not limited to: I2C, DIO, Analog, encoder and RS485 connections)	28 AWG (29 SWG or .08 mm ²)

Integrated wires originally attached to legal COTS devices or wires included/sold by the manufacturer are considered part of the device and by default legal. Such wires are exempt from this rule.

In order to show compliance with these rules, teams should use wire with clearly labeled sizes if possible. If unlabeled wiring is used, teams should be prepared to demonstrate that the wire used meets the requirements of this rule (e.g., wire samples and evidence that they are the required size).

Combining multiple smaller wires in parallel cannot be used to create an equivalent larger wire which meets minimum wire cross section requirements.

R616 *Use specified wire colors. All non-SIGNAL LEVEL wiring with a constant polarity (i.e., except for outputs of motor controllers, or sensors) shall be color-coded along their entire length from the manufacturer as follows:

- A. red, yellow, white, brown, or black-with-stripe on the positive (e.g., +12VDC, +5VDC) connections, and
- B. black or blue for the common or negative side (-) of the connections.

Exceptions to this rule include:

- C. wires that are originally attached to legal devices and any extensions to these wires using the same color as the manufacturer.

Multi-conductor (also known as multi-core) cables that do not adhere to the specified color-coding may be used, on the condition that the insulation of all exposed conductors is re-identified to comply with the rule. This can be achieved by applying colored electrical tape, colored heat shrink, or another compliant method to distinguish each conductor.

R617 *Powered USB hubs must draw energy from approved sources. Powered USB hubs used on the ROBOT can only be powered through one of the following ways:

- A. an approved COTS USB battery Pack per [R602](#), or
- B. the 5V auxiliary power port on the REV Expansion Hub or REV Control Hub.

R618 ***Do not modify critical power paths.** CUSTOM CIRCUITS shall not directly alter the power or control pathways between:

- A. the ROBOT battery and main power switch,
- B. the main power switch and a power regulating device (per [R609](#)),
- C. any two power regulating devices (per [R613](#)), or
- D. power regulating devices and actuators.

Custom high impedance voltage monitoring or low impedance current monitoring circuitry connected to the ROBOT'S electrical system is acceptable if the effect on power pathways is inconsequential.

Altering a power pathway includes, but is not limited to, altering the voltage of the power pathway using a boost (DC voltage step-up) or buck (DC voltage step-down) converter or otherwise altering the natural variable DC voltage provided by the ROBOT battery to create a constant DC voltage.

Devices that modify actuator control signals or power (except those allowed by [R505](#)) are prohibited, such as the goBILDA Servo Travel Tuner.

R619 ***Do not mix and match power on or between power regulation devices.** The following rules must be adhered to when using power on any power regulation device (per [R505](#)):

- A. other than power used to energize the power regulation device (per [R614](#)) no power originating outside the power regulation device may be used on or with devices connected to the power regulation device. The only exceptions are connections intended for communication between devices (RS485/USB/PWM/etc.),

Example 1: The +5V port on a REV Expansion Hub cannot be used to power devices connected to a REV Control Hub's I2C ports.

Example 2: A regulated 5V output provided by a CUSTOM CIRCUIT cannot be used to power an I2C device connected to a REV Control Hub.

- B. power originating from ports/connectors on power regulation devices may only be used for devices directly connected to that port/connector. The only exception to this is +5V power from the +5V power port on the REV Control Hub or REV Expansion Hub may be used in conjunction with any Analog, Digital, or I2C port on that device. In addition, the +5V power port may be used to power external devices, and

Example 1: The power provided by Digital Port 0-1 on a REV Control Hub should not be used to power devices connected to I2C Port 0. However, power provided by Digital Port 0-1 can be used to power devices connected to both signal channels N and N+1 on Digital Port 0-1.

Example 2: The +5V power can be used to power external devices such as externally powered USB hubs (per [R617](#)).

Example 3: The power provided by multiple servo ports cannot be combined into a single power bus for one or more servos.

- C. 6V power provided by the goBILDA 6V Servo Power Injector, REV Servo Power Module, REV Robotics Servo Hub, or Studica Servo Power Block may only be used for powering servos.

12.7 Control, Command & Signals System

R701 ***Control the ROBOT with a single ROBOT CONTROLLER.** ROBOTS must be controlled via 1 programmable ROBOT CONTROLLER. The ROBOT CONTROLLER is the only source of control for the ROBOT actuators and must be comprised of:

- A. REV Control Hub (REV-31-1595), or
- B. an allowed smartphone Android device connected to a REV Expansion Hub (REV-31-1153)

In addition to A or B, a ROBOT may also contain:

- C. no more than one additional REV Expansion Hub (REV-31-1153).

R702 ***Teams may not alter coprocessor software.** Modifying software on coprocessors, unless explicitly permitted in this rule or rule [R703](#), is not allowed by teams. Firmware updates in binary form provided by the manufacturer may be applied as directed by the manufacturer.

The following are examples of allowed devices:

Example 1: The Adafruit BNO055 Absolute Orientation Sensor is an IMU package with an onboard ARM Cortex-M0 based coprocessor to crunch sensor data and produce composite output. Its coprocessor contains software that is not intended by the manufacturer to be modified by users.

Example 2: The SparkFun Optical Tracking Odometry Sensor is a laser and IMU tracking device that uses an onboard microcontroller to perform complex calculations and produce simplified results. SparkFun does provide the source code and toolchain for advanced users to modify/update the software, which is not permitted by this rule. Firmware updates provided by SparkFun are allowed to be applied to the device.

Example 3: The Digital Chicken Labs OctoQuad FTC Edition is an 8-channel encoder/PWM interface, utilizing a Raspberry Pi Pico coprocessor. Teams are not permitted to modify software running on the device, including replacing the software with their own. Updates provided in binary form by the manufacturer (Digital Chicken Labs) may be applied to the device.

R703 ***Some vision coprocessors can be programmed.** Programmable vision coprocessors that are natively supported by the FTC SDK may be programmed. The programmable vision coprocessors that are supported are:

Table 12-9: Supported programmable vision coprocessors

Device	Part Number
Limelight Vision Limelight 3A	LL_3A

Example 1: Optical Flow sensors are an example of a sensor that utilizes a vision coprocessor that is treated no differently than other coprocessors per [R702](#).

Example 2: The DFRobot HuskyLens and the Charmed Labs Pixy2 are examples of vision coprocessors that are configurable but not programmable and are treated no differently than other coprocessors per [R702](#).

Example 3: The OpenMV Cam, Luxonis OAK-1, and LimeLight Vision Limelight 3G are examples of programmable vision coprocessors that are prohibited.

See [R715](#) for more information regarding vision coprocessor support.

R704 *Use only legal Android smartphone devices. Android smartphone devices, if used, must minimally be running the Android 7 (Nougat) operating system. The following table lists the legal Android smartphones:

Table 12-10: Legal Android Smartphones

Phone	Notes
Motorola Moto G4 Play	Sometimes noted as “4th Generation”
Motorola Moto G5	
Motorola Moto G5 Plus	
Motorola Moto E4	USA versions only, includes SKUs XT1765, XT1765PP, XT1766, and XT1767
Motorola Moto E5	XT1920
Motorola Moto E5 Play	XT1921

Some supported models still using Android 6.x (Marshmallow) might be updatable by the [Motorola Software Fix Tool](#).

Teams outside North America with extenuating circumstances (such as international purchasing limitations) are allowed to use alternate Android smartphones if necessary. Teams doing so must send an email each season to customerservice@firstinspires.org with the following details:

- Subject of email should be: “Alternate FTC Android Phone Use”
- Team number and region, including reason for using an alternate smartphone
- Smartphone make and model, including version of Android OS in use

- R705 *Smartphone android devices used as a ROBOT CONTROLLER must connect to the REV Expansion Hub using USB.** If used as a ROBOT CONTROLLER, the smartphone android device must be connected via its integrated micro-USB port to a REV Expansion Hub either:
- A. a mini-USB to OTG Micro Cable, or
 - B. any combination of Mini USB Cable, a USB Hub (powered or unpowered) and an OTG Micro adaptor (the OTG functionality can be integrated into the USB Hub).
- R706 *Bandwidth is restricted.** Software with access to the ROBOT network must limit the amount of data being streamed (i.e., continuous transmission of data) over Wi-Fi. Software may only stream robot control data, debugging data, and telemetry to and from the ROBOT. No continuous video stream is allowed.
- R707 *Configure devices for your team number.** The ROBOT CONTROLLER, DRIVER STATION, and any spares used must be configured/named to correspond to the correct team number as follows:
- A. ROBOT CONTROLLER should be named <team number>-RC (e.g., 12345-RC),
 - B. DRIVER STATION should be named <team number>-DS (e.g., 12345-DS), and
 - C. If a spare ROBOT CONTROLLER or DRIVER STATION is configured, a letter designator may be added <team number>-<letter>-RC/DS (e.g., 12345-A-DS, 12345-B-DS)

See the [DRIVER STATION Instructions](#) and [ROBOT CONTROLLER Instructions](#) for a detailed procedure for updating DRIVER STATION and ROBOT CONTROLLER “names.”

- R708 *Do not interfere with the ROBOT networks.** During a MATCH, all communications signals must originate from only the ROBOT CONTROLLER device or the DRIVER STATION device using the ROBOT CONTROLLER Wi-Fi network. No other devices may attempt to connect to, interfere with, or alter the ROBOT CONTROLLER Wi-Fi network.

Teams are allowed to connect programming laptops and other devices to the ROBOT CONTROLLER Wi-Fi network outside of a MATCH. These devices must be disconnected from the ROBOT CONTROLLER Wi-Fi network prior to and during a MATCH.

- R709 *No other wireless allowed.** No form of wireless communication shall be used to communicate to, from, or within the ROBOT, except those specified per [R706](#) and [R708](#).

Devices that employ signals in the visual spectrum (e.g., cameras) and non-RF sensors that do not receive human-originated commands (e.g., “beam break” sensors or IR sensors on the ROBOT used to detect FIELD elements) are not wireless communication devices and thus this rule does not apply.

- R710 *Use assigned Wi-Fi bands and/or channels if requested.** Teams may be asked by the Event Director to use a specific Wi-Fi frequency band or channel on the day of competition. If requested, teams are required to do so. Teams may work with the FTA or wireless technical advisor (WTA) to find an alternate frequency band or channel if the suggested band/channel is deemed problematic by the FTA or WTA.

R711 *ROBOT CONTROLLER must be visible for inspection. The ROBOT CONTROLLER device must be mounted on the ROBOT such that the diagnostic lights, or device screen if applicable, can be visible for inspection.

“Visible for inspection” does not require that the items be visible when the ROBOT is in STARTING CONFIGURATION or normally during a MATCH, provided the team can make the items viewable during the inspection process if necessary.

Teams are strongly encouraged to make the diagnostic lights visible during normal MATCH play ROBOT configurations. If diagnostic LEDs are not visible during a MATCH, FIELD STAFF may not be able to provide comprehensive support to the team.

Teams are encouraged to mount the ROBOT CONTROLLER device away from noise generating devices such as motors and EMF shielding materials like sheets of metal.

R712 *Only specified modifications to core control system devices permitted. The DRIVER STATION device and software, Android-based ROBOT CONTROLLER device, main and secondary power switch(es), power regulation devices, fuses, and batteries shall not be tampered with, modified, or adjusted in any way (tampering includes drilling, cutting, machining, rewiring, disassembling, painting, removing enclosures and replacing with custom enclosures, etc.), with the following exceptions:

- A. wires, cables, and signal lines may be connected via the standard connection points provided on the devices,
- B. fasteners (including adhesives) may be used to attach devices to the OPERATOR CONSOLE or ROBOT or to secure cables to the device,
- C. thermal interface material may be used to improve heat conduction,
- D. labeling may be applied to indicate device identification, purpose, connectivity, functional performance, etc. as long as they do not cover labels or markings used to identify the product,
- E. jumpers may be changed from their default location,
- F. jumpers or switches may be moved to configure devices per the manufacturer’s manual,
- G. device firmware may be updated with manufacturer supplied firmware,
- H. integral wires on motor controllers and batteries may be cut, stripped, and/or connectorized,
- I. devices except batteries may be repaired, provided the performance and specifications of the device after the repair are identical to those before the repair,
- J. add insulating material to exposed conductors,
- K. tape may be applied for debris protection, and
- L. power switch mounting brackets can be modified or replaced.

Please note that while repairs are permitted, the allowance is independent of any manufacturer’s warranty. Teams make repairs at their own risk and should assume that any warranty or return options are forfeited. Repairs must be functionally equivalent to original device condition.

Be aware that diagnosing and repairing COMPONENTS such as these can be difficult.

For example, “repairs” that change connector types, include device footprint modifications, or provide mechanical enhancements, are prohibited.

R713 ***Always keep control system device software up to date.** The following table lists the recommended software versions for each core control electronics module, and a link on how to update this software. Note that some devices have multiple pieces of software that may need to be updated each season, and not all software is available prior to Kickoff each season. Check the [FIRST Tech Challenge Blog](#) for release announcements.

Regardless of the versions selected, it is highly recommended that the installed ROBOT CONTROLLER App and DRIVER STATION App versions match major and minor values to ensure compatibility as not all software versions are compatible with each other.

Table 12-11: Recommended Software for Control System Devices

Device	Software and Minimum Recommended Versions	How to Update
REV Control Hub (REV-31-1595)	Control Hub OS Recommended: 1.1.2	Updating the Control Hub OS
REV Control Hub (REV-31-1595)	Hub Firmware Recommended: 1.8.2	Updating the Hub Firmware
REV Control Hub (REV-31-1595)	ROBOT CONTROLLER App Recommended: 11.0	Updating the ROBOT CONTROLLER App
REV Expansion Hub (REV-31-1153)	Hub Firmware Recommended: 1.8.2	Updating the Hub Firmware
Android Smartphone (ROBOT CONTROLLER device)	ROBOT CONTROLLER App Recommended: 11.0	Updating the ROBOT CONTROLLER App
Android Smartphone (DRIVER STATION device)	DRIVER STATION App Recommended: 11.0	Updating the DRIVER STATION App
REV Driver Hub (REV-31-1596)	Driver Hub OS Recommended: 1.2.0	Updating the Driver Hub OS
REV Driver Hub (REV-31-1596)	DRIVER STATION App Recommended: 11.0	Updating the DRIVER STATION App
REV Servo Hub (REV-11-1855)	REV Servo Hub Firmware Recommended: 25.0.2	Updating the REV Servo Hub

Software at or above the recommended versions have the latest bugfixes and updates. Teams are highly encouraged to update their software minimally to the recommended version. FIELD STAFF will not be able to provide comprehensive support to teams with software older than the recommended version.

Teams may choose to run older versions without affecting their ROBOT inspection status.

- R714 *USB is for vision.** Only the following devices may be connected to the ROBOT control system using USB:
- webcams and optical vision sensors per [R715](#),
 - USB hub or USB switch, and
 - a REV Expansion Hub.
- R715 *Use only supported USB vision.** Only single image sensor vision devices that are natively supported by the ROBOT CONTROLLER app are allowed to connect to USB (stereoscopic cameras are not allowed). This includes the following:
- all UVC compatible USB webcams (Logitech C270, and related), and
 - Vision coprocessors allowed per [R703](#).
- UVC compatible USB webcams may only use the UVC provided stream / data. No other interfaces or data provided by the webcam may be used.

To request support (or to provide sample drivers) for alternate USB vision devices for inclusion in future *FIRST* Tech Challenge seasons, please send an email to customerservice@firstinspires.org with the following details:

 - Subject of email should be: “USB Vision Future Support Request”
 - Contact details for providing feedback or clarifications
 - Details on the device requesting support
- R716 *Recording devices are okay.** Self-contained video recording devices (GoPro or similar) are allowed providing they are used only for non-functional post-MATCH viewing and the wireless capability is turned off.
- R717 *Lasers must be safe.** Lasers are not allowed unless they meet all of the following criteria:
- must be part of a sensor,
 - must be rated as IEC/EN 60825-1” Class I” or IEC/EN 62471 “Exempt,” and
 - non-visible spectrum.
- R718 *Configure Android devices appropriately.** ROBOT CONTROLLER and DRIVER STATION Android devices (smartphones, REV Control Hub, REV Driver Hub) must additionally be configured in the following ways:
- REV Control Hub users must [change the Wi-Fi password](#) to a non-default password,
 - smartphone users must enable Airplane Mode,
 - on ROBOT CONTROLLER and DRIVER STATION Android devices, Wi-Fi must be enabled and Bluetooth must be disabled, and
 - on smartphones and REV Driver Hub, remove all remembered Wi-Fi Direct Groups and Wi-Fi connections, leaving only the ROBOT CONTROLLER Wi-Fi connection.

12.8 Pneumatic Systems

In order to maintain safety, the rules in this section apply at all times while at the event, not just while the ROBOT is on the FIELD for MATCHES.

R801 *No Pneumatics. No closed air systems are allowed on *FIRST* Tech Challenge ROBOTS except for those explicitly listed in [R207](#).

12.9 OPERATOR CONSOLE

R901 ***Use only a specified DRIVER STATION device.** The OPERATOR CONSOLE may only have one approved android-based DRIVER STATION device connected and powered on. The OPERATOR CONSOLE must have at least one of the following:

- A. REV Driver Hub (REV-31-1596), or
- B. Approved Android Device from rule R704 with one OTG cable and COTS USB cable to connect the required gamepad controller(s).

Teams who wish to have a spare DRIVER STATION device as part of their OPERATOR CONSOLE may do so as long as only one DRIVER STATION device is connected and powered on at a time.

R902 ***The OPERATOR CONSOLE must make the touch screen accessible.** The OPERATOR CONSOLE, the set of COMPONENTS and MECHANISMS used by the DRIVE TEAM to relay commands to the ROBOT, must make the touch screen of the DRIVER STATION device accessible. The DRIVER STATION device must be positioned within the OPERATOR CONSOLE so that the screen display can be clearly seen during inspection and in a MATCH. The DRIVER STATION device touch screen must be functional without the requirement of additional aides (e.g., mouse) in order to be used.

R903 ***Only limited gamepads are supported.** The OPERATOR CONSOLE may have no more than 2 electrically unmodified gamepads in any combination from the following list connected to the DRIVER STATION at any time:

Table 12-12: Allowed Gamepads on OPERATOR CONSOLE

Gamepad	Part Number	Notes
Logitech F310 gamepad	940-00010	
Xbox 360 Controller for Windows	52A-00004	
Sony DualShock 4 Wireless Controller for PS4	N/A	Operating in wired mode only (i.e., connected through USB cable without being Bluetooth paired to any device)
Sony DualSense Wireless Controller for PS5	N/A	This DOES NOT include the Sony DualSense Edge Wireless Controller in any configuration
Etpark Wired Controller for PS4	REV-39-1865	Newer versions of this device may not support all functionality provided by the FTC SDK
REV Robotics USB PS4 Compatible Gamepad	REV-31-2983	
Quadstick game controller in Xbox 360 Emulation Mode	any model	

Enhancements to the gamepad (e.g. back paddles) that do not modify the electronics are legal. Adding a [ferrite cable clip](#) to gamepad cables close to the

USB connector is highly recommended. Different color gamepads are allowed provided they are the same model as the allowed gamepad.

Teams are strongly encouraged to use short [USB cable extenders](#) with the USB ports on the DRIVER STATION device. These extenders are used to reduce the wear and tear on the DRIVER STATION device ports from frequent plugging and unplugging – instead of plugging/unplugging directly into the DRIVER STATION device, gamepads are plugged and/or unplugged from the cable extenders. The extenders are intended to remain forever plugged into the DRIVER STATION device and, with proper strain relief employed, can protect the port from accidental damage.

Teams who wish to have spare gamepad(s) available as part of their OPERATOR CONSOLE may do so as long as no more than 2 gamepads are connected at any time.

- R904 *OPERATOR CONSOLE physical requirements.** The OPERATOR CONSOLE, including all power sources, must not exceed a volume of 3ft wide, 1ft 2in deep and 2 ft tall (91.4 cm by 35.5 cm by 61.0 cm) excluding any items that are held or worn by the DRIVERS during the MATCH.

Please note that while there is no hard weight limit, OPERATOR CONSOLES that weigh more than 20 lbs. (~9 kg.) will invite extra scrutiny as they are likely to present unsafe circumstances.

Teams who wish to have a spare external USB hub as part of the OPERATOR CONSOLE may do so as long as only one USB hub is connected at any time.

- R905 *ROBOT application wireless communication only.** Other than the connection controlled by the ROBOT CONTROLLER app running on the ROBOT and the DRIVER STATION app running on the DRIVER STATION device, no other form of wireless communications shall be used to communicate to, from, or within the OPERATOR CONSOLE during a MATCH.

Examples of prohibited wireless systems include, but are not limited to, active wireless network cards and Bluetooth devices.

Because this system uses a built-in wireless radio, teams are strongly encouraged to ensure there is no metal material blocking the line-of-sight between the DRIVER STATION device and the ROBOT CONTROLLER device which could impede the signal quality.

- R906 *No unsafe or unfair OPERATOR CONSOLES.** OPERATOR CONSOLES shall not be made using hazardous materials, be unsafe, cause damage, cause an unsafe condition, distract, or interfere with other DRIVE TEAMS or the operation of other ROBOTS.

DRIVER STATION sounds which are distracting or which mimic MATCH sounds are examples of disallowed OPERATOR CONSOLE features.

Sounds which are frequent or continuous which serve no apparent value to the MATCH play would likely be considered distracting.

The intent of this rule is to allow teams to use a container to store, organize, and transport the DRIVER STATION device and supporting electronics. The OPERATOR CONSOLE rules are not intended to allow systems that function as a ROBOT cart or replace a competition-provided OPERATOR CONSOLE stand, table, etc.

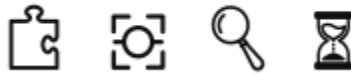

13 Tournament (T)

13.1 Overview

Each *FIRST* Tech Challenge competition is played in a head-to-head tournament format. Each tournament may consist of Qualification MATCHES and Playoff MATCHES.

Qualification MATCHES allow each team to earn MATCH points and RANKING POINTS which determine their seeding position and may qualify them for participation in the Playoff MATCHES.

Playoff MATCHES determine the event winning ALLIANCE.

These rules apply to all event types described in section [4 Advancement](#). Additional rules may apply to League Meets and League Tournaments as covered by section [14 League Play Tournaments \(L\)](#).

13.2 General Tournament Rules

T201 ***The Head REFEREE has ultimate and final authority regarding gameplay during the event.** The Head REFEREE may receive input from additional sources, e.g., *FIRST* personnel, FTA, Event Director, Program Delivery Partner, and other event staff. The Head REFEREE rulings are final. No event staff, including the Head REFEREE, will review video, photos, artistic renderings, etc. of any MATCH, from any source, under any circumstances.

- A. When issuing a RED CARD or YELLOW CARD the Head REFEREE must record the rule violation.
- B. Event Directors and Program Delivery Partners may not overrule a Head REFEREE decision.
- C. *FIRST* Code of Conduct and Egregious violations may involve escalation beyond the Head REFEREE'S initial ruling.
- D. Every Qualification and Playoff MATCH must be observed by a certified Head REFEREE. Head REFEREES may only watch 1 MATCH at a time.

Rules in this manual are written for *human* Head REFEREES to enforce. Some have clear unambiguous criteria which can be easily checked, but other rules will rely on human judgement. Head REFEREES are asked to make the best call they can in the moment with what they or other REFEREES observed during the MATCH.

When there is an ambiguous situation or controversial call it is human instinct to wonder what was the "right call" or "what-if.." – for the purposes of *FIRST* Tech Challenge gameplay, the right call is the one that was made in good faith by the Head REFEREE with the information they had available at the time.

T202 ***Only REFEREES can declare a ROBOT DISABLED.** A ROBOT is only considered DISABLED once a REFEREE has declared the ROBOT DISABLED during a MATCH. A ROBOT may be DISABLED as a consequence of a rule violation or due to a ROBOT failure. If a REFEREE DISABLES a ROBOT as a consequence for a rule violation, the REFEREE may instruct the team to drive the ROBOT to a specific neutral position on the FIELD before DISABLING.

T203 *The Event Director has ultimate authority regarding all non-gameplay decisions during an event. The Competition Manual is intended to provide a set of rules for the competition including gameplay and judging but it is not an exhaustive compilation of guidelines for running a *FIRST* Tech Challenge event. Issues outside of specific gameplay rules which are under the authority of the Head REFEREE per [T201](#) are at the discretion of the Event Director such as, but not limited to:

- A. venue access as published via the public schedule
- B. pit sizes and utility access
- C. health and safety
- D. team registration and competition eligibility
- E. team conduct away from the ARENA

T204 *All competition FIELDS at an event must be consistent with each other. Events which have multiple competition FIELDS (as indicated by the MATCH schedule Figure 13-1) will be consistent with each other. Examples of set-up which must be considered includes but is not limited to:

- A. elevation of the FIELD off the floor
- B. FIELD display monitors
- C. FIELD perimeter type
- D. FIELD TILE size and type

Other FIELDS (e.g., practice FIELDS) at the event do not need to be consistent with each other or competition FIELDS.

T205 *During optional FIELD measurement and calibration time(s) ROBOTS may not practice on the FIELD. During any period when the ARENA is open for measurement, ROBOTS may run OpModes but cannot move the ROBOT (e.g., CHASSIS) under its own power around the FIELD.

Violation: VERBAL WARNING. YELLOW CARD if subsequent violations during the event.

At the discretion of the Event Director at the event, the ARENA may be open for at least 30 minutes prior to the start of Qualification MATCHES, during which time teams may survey and/or measure the ARENA and bring ROBOTS on the FIELD to perform sensor calibration. The specific time that the FIELD is open will be communicated to teams at the event. Teams may bring specific questions or comments to the Head REFEREE or FTA.

Allowed activities during ROBOT calibration and measurement time(s) include:

- A. ROBOT may be powered on.
- B. Team may initialize an OpMode.
- C. ROBOT may operate or extend MECHANISMS outside the ROBOT CHASSIS.
- D. ROBOT may CONTROL SCORING ELEMENTS.
- E. ROBOT may be connected to programming laptops and other devices.
- F. Team members may be on the FIELD with the ROBOT.
- G. Team members may manually move the ROBOT to multiple positions around the FIELD (e.g., without driving the ROBOT under its own power).
- H. Team members or ROBOTS may measure the FIELD with tools (e.g., tape measures) or sensors.

Activities not allowed during ROBOT calibration and measurement time(s) include:

- I. ROBOT CHASSIS may not move under its own power around the FIELD (i.e., “driving” as part of AUTO or TELEOP).
- J. ROBOT may not LAUNCH SCORING ELEMENTS.
- K. HUMAN PLAYER may not practice (e.g., repetitive actions by a TEAM member in the ALLIANCE AREA placing/retrieving SCORING ELEMENTS).

T206 *No team timeouts, but MATCHES have breaks. Teams playing in back-to-back MATCHES will have a minimum break between their MATCHES as follows:

- A. In Qualification MATCHES, each team will have a minimum of 5 minutes from when the MATCH results are posted from their previous match until the expected start time of their next MATCH for the purpose of [G301](#).
- B. In Playoff MATCHES, each team will have a minimum of 8 minutes from when MATCH results are posted from their previous MATCH until the expected start time of their next MATCH for the purpose of [G301](#).

If a MATCH'S results will not be posted, (e.g., due to an immediate replay) each team will be afforded a reasonable time to reset at the Head REFEREE'S discretion.

These breaks are automatically tracked by the *FIRST* event management system. FIELD STAFF will communicate expected start times with teams as appropriate. Teams may ask the Head REFEREE or their designee about the timing of affected MATCHES.

During *FIRST* Championship da Vinci round-robin Playoff MATCHES, each team will have a minimum break of 8 minutes from when a MATCH concludes until the expected start time of their next MATCH for the purpose of [G301](#).

T207 *MATCHES are played in order Qualification and Playoff MATCHES will be played in numerical order except for extenuating circumstances at the discretion of the Head REFEREE in consultation with the Event Director. All Qualification MATCHES must be played before the start of ALLIANCE selection and all Playoff MATCHES for the current round must be played before the start of the next round. The timing of MATCHES played out of order or replayed MATCHES will be communicated by FIELD STAFF or event personnel to the teams involved.

Extenuating circumstances that might lead to a MATCH being played out of order include, but are not limited to:

- A. A MATCH replay occurring at the next available break, end of day, at the conclusion of other Qualification MATCHES, or the end of the current playoff round.
- B. A lengthy repair on one competition FIELD preventing MATCH play from continuing on on that FIELD, but other FIELDS may continue to be used.
- C. Urgent and extenuating circumstances related to a team.

The intent of this rule is to ensure that MATCHES are played in an orderly fashion while providing flexibility for unforeseen circumstances. Regardless of play order, [T206](#) and [G301](#) remain in effect.

13.3 MATCH Replays

T301 *Replays are allowed, but rare. MATCH replays are only allowed in extreme circumstances due to an ARENA FAULT or for MATCHES which are stopped because FIELD STAFF anticipated FIELD damage or personal injury.

An ARENA FAULT is an error in ARENA operation that includes, but is not limited to:

- A. broken FIELD elements due to normal, expected game play, or ROBOT abuse of FIELD elements that affects the outcome of the MATCH for their opponents,

A broken FIELD element caused by ROBOT abuse that affects the outcome of the MATCH for their ALLIANCE is not an ARENA FAULT. The following situations in DECODE are typically not considered ARENA FAULTS:

- A. An ARTIFACT jam in the GOAL behind the archway,
- B. An ARTIFACT jam on the CLASSIFIER,
- C. A GOAL slightly lifts off the TILES , or
- D. A GATE temporarily sticks open.

The following situations for DECODE are typically considered ARENA FAULTS:

- E. An opponent bends or breaks off a GATE such that it no longer operates normally, or
- F. An opponent causes a GATE to stick open for a substantial or impactful portion a MATCH.

- B. FIELD elements moving beyond normal tolerances (not as the result of ROBOT interaction)
- C. Wide-spread wireless interference affecting multiple ROBOTS typically at the same time and on both ALLIANCES,
- D. failure of the MATCH timer display, or
- E. errors by FIELD STAFF (except those listed in section [10.8 Other Logistics](#)).

To replay a MATCH the Head REFEREE must determine that an ARENA FAULT which is MATCH affecting has occurred and a team on the affected ALLIANCE must request the replay. In addition, FIRST Headquarters reserves the right to, with consultation of the Head REFEREE and FIELD STAFF, replay any MATCH in which an ARENA FAULT impacts the outcome of an event.

Unexpected ROBOT behaviors which are the fault of the team are not justifications for a replay. Conditions such as, but not limited to low ROBOT battery, programming issues, or ROBOT mechanical problems are not grounds for a replay.

The outcome of the MATCH is affected if an error occurs that, in the judgement of the Head REFEREE, changes which ALLIANCE would have won the MATCH and/or the assignment of RANKING POINTS.

The outcome of an event is affected if an error occurs that, in the judgement of FIRST Headquarters, changes the assignment of RANKING POINTS or has a dramatic effect on points used for ranking criteria.

Note that an ARENA FAULT that does not affect MATCH outcome, in the judgement of the Head REFEREE, does not lead to a MATCH replay. Examples include, but are not limited to:

- A. a piece of FIELD plastic falls into the FIELD, far away from any human or ROBOT activity, and in such a way that it does not affect MATCH outcome,
- B. delay in the playing of an ARENA sound, and
- C. any adjustment or delay in assignment of a penalty or scoring achievement (including those made after the MATCH).

T302 *Replays will replicate the conditions of the original MATCH. All reasonable effort is made to create the same conditions when replaying a MATCH caused by an ARENA FAULT or FIELD damage. This includes:

- A. a ROBOT that was not present for the MATCH or DISABLED prior to the start of the original MATCH, which is to be replayed, is DISABLED for the replay MATCH
- B. the same FIELD will be used unless otherwise deemed necessary by the Head REFEREE due to severity of FIELD damage

Exceptions to this rule are:

- C. ROBOT and DRIVE TEAM starting locations and pre-loaded SCORING ELEMENTS do not need to be replicated when replaying a MATCH

While efforts will be made to replicate the same conditions of the original MATCH, there are environmental factors, such as changes to ambient lighting, that may be outside the control of the event.

13.4 Clarifications on MATCH Play Results (“Question Box”)

Each event will have one or more designated Question Boxes in the ARENA area. If a DRIVE TEAM has a question about a MATCH, the FIELD, etc., they may send one STUDENT wearing a DRIVE TEAM badge to their corresponding Question Box. Depending on timing, the Head REFEREE or FTA may postpone any requested discussion until the end of the subsequent MATCH.

Technical questions regarding FIELD or ROBOT operation are addressed by the FTA, and additional team members are invited to participate in these conversations if necessary. If a DRIVE TEAM needs clarification on a ruling or MATCH results, per [T401](#), one STUDENT should address the Head REFEREE after the MATCH results have been shown.

While the *FIRST* event management software tracks quantities of MINOR and MAJOR FOULS, *FIRST* instructs REFEREES to not self-track details about MINOR FOULS and MAJOR FOULS; as a result, we do not expect REFEREES to recall details about what MINOR FOULS and MAJOR FOULS were made, when they occurred, and against whom.

Any reasonable question is fair game in the Question Box, and Head REFEREES will make good faith efforts to provide helpful feedback (e.g., how/why certain FOULS are being called, why a particular ROBOT may be susceptible to certain FOULS based on its design or gameplay, how specific rules are being called or interpreted), but please know that they may not be able to supply specific details.

T401 *1 STUDENT, 1 Head REFEREE. A team may only address the Head REFEREE with 1 STUDENT. The STUDENT may be accompanied by at most 1 silent observer, who may be an adult or a STUDENT.

Violation: The Head REFEREE will not address additional, non-compliant team members or peripheral conversations.

T402 *MATCH questions must be timely. If a team would like to clarify or dispute the results of a MATCH using the process per [T401](#) they must present their STUDENT representative in the question box in a timely manner as outlined below:

- A. questions regarding events in a Qualification MATCH may be asked at any time before ALLIANCE selection begins, or within 5 minutes of the last Qualification MATCH at events without Playoff MATCHES
- B. questions regarding events in a Playoff MATCH must be asked before the start of the next Playoff round or, for the last Playoff MATCH, immediately following the MATCH.

Please keep in mind that our REFEREES are human, and the more time has passed between the MATCH in questions, the less likely they are to remember the details of a specific MATCH. It is best to ask for clarification or to dispute the results of a MATCH within 3 MATCHES.

Teams are encouraged to ask questions as soon as possible. Questions asked more than 5 minutes after the last Playoff MATCH will likely not be addressed.

T403 *Keep questions factual and constructive. Teams coming to the Question Box should think through their requests in advance and are encouraged to have relevant references to rules or the [Q&A website](#) available to aid discussions.

There should be no negative implications for teams using the question box to advocate for themselves, but everyone should keep in mind it can be a high stress situation for team youth and for volunteers alike and it is important to remember *FIRST* [Core Values](#) during these discussions.

At some events, MATCH results may be available on the [FTC-Events](#) page.

13.5 Practice MATCHES

Practice MATCHES are played before Qualification MATCHES, at events that have them. The Practice MATCH schedule is available as soon as possible but no later than the start of Practice MATCHES. Schedules may also be available on the [FTC-Events](#) site if the tournament is connected to the internet. Practice MATCHES are randomly assigned, and teams may not switch scheduled Practice MATCHES. Each team is assigned an equal number of Practice MATCHES unless the number of teams multiplied by number of Practice MATCHES is not divisible by 4. In this case, the event management software randomly selects some teams to play an extra Practice MATCH.

Practice MATCHES are not guaranteed at all events due to schedule constraints.

13.5.1 Filler Line

A Filler Line is used to fill open slots at events that employ scheduled Practice MATCHES or all slots at events with an open Practice MATCH schedule. Teams from the Filler Line are used on a first come, first served basis to fill empty spots in Practice MATCHES left by other teams that do not report to Queueing. The number of teams in the Filler Line is dependent upon space at venues.

Only teams that meet all criteria below qualify for the Filler Line:

- A. ROBOTS in the Filler Line must have passed inspection (this requirement may be waived for events with open Practice MATCH schedules),
- B. DRIVE TEAMS must join the Filler Line with their ROBOT,
- C. teams may not work on their ROBOT while in the Filler Line,
- D. teams may not occupy more than 1 spot in the Filler Line, and
- E. if a team is queued for their Practice MATCH, they may not also join the Filler Line.

13.6 Qualification MATCHES

13.6.1 Schedule

The Qualification MATCH schedule is made available as soon as possible, but no later than 15 minutes before Qualification MATCHES are scheduled to begin. Only teams who are eligible and have completed check-in on time will be included in the schedule per [I102](#) and [E105](#). Teams will receive access to the schedule through one or more of the following methods: 1 printed hard copy, notice of publicly posted hardcopy available to photograph, and/or local digital schedule display. Schedules may also be available on the [FTC-Events](#) site if the tournament is connected to the internet. Each qualification schedule consists of a series of rounds in which each team plays 1 MATCH per round.

All event types will schedule either 5 or 6 Qualification MATCHES per team as determined by the Event Director based on available schedule time allocated. *FIRST* Championship, *FIRST* Premier Events, and Regional Championship Tournaments may schedule more MATCHES per team at the discretion of *FIRST* Headquarters and the Event Director.

A MATCH schedule is used to coordinate MATCHES at an event. Figure 13-1 details information shown on each schedule. SURROGATE MATCHES are described in section [13.6.2 MATCH Assignment](#).

Figure 13-1: Sample MATCH Schedule

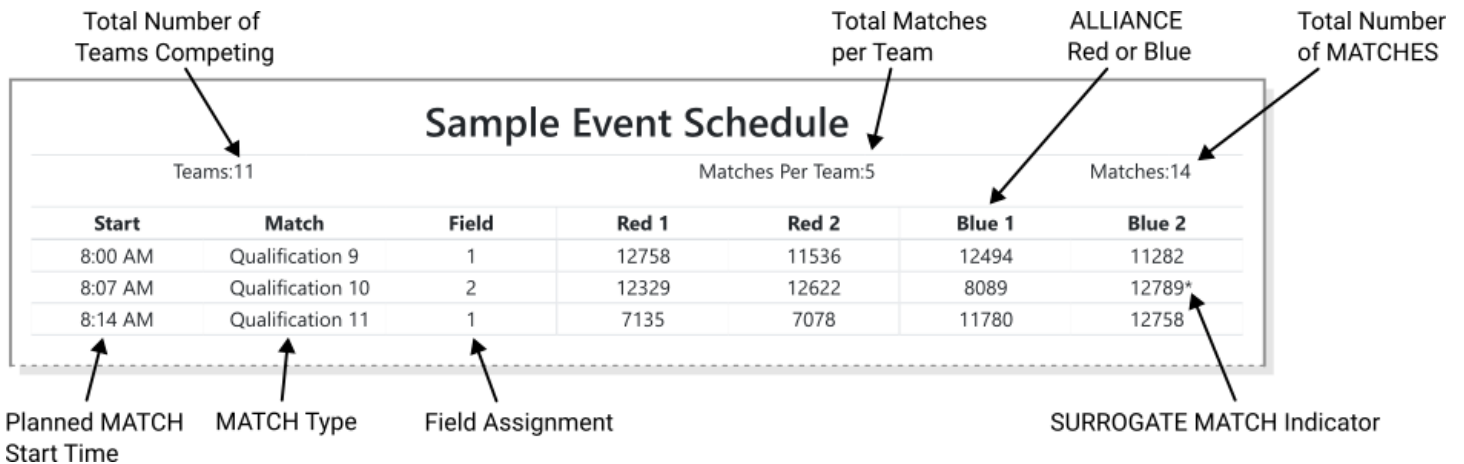

Start	Match	Field	Red 1	Red 2	Blue 1	Blue 2
8:00 AM	Qualification 9	1	12758	11536	12494	11282
8:07 AM	Qualification 10	2	12329	12622	8089	12789*
8:14 AM	Qualification 11	1	7135	7078	11780	12758

13.6.2 MATCH Assignment

FIRST event management software assigns each team 1 ALLIANCE partner for each Qualification MATCH using a predefined algorithm, and teams may not switch Qualification MATCH assignments. The algorithm employs the following criteria, listed in order of priority:

1. ensure each team has at least the minimum required time between MATCHES (varies by event size)
2. minimize the number of times a team is allied with any team
3. minimize the number of times a team plays opposite any team
4. minimize the use of SURROGATES (teams randomly assigned by event management software to play an extra Qualification MATCH)
5. provide even distribution of MATCHES played on blue and red ALLIANCE

For more information about the MATCH scheduling algorithm, please see [Idle Loop software's website](#).

All teams are assigned the same number of Qualification MATCHES, equal to the number of rounds, unless the number of teams multiplied by number of MATCHES is not divisible by 4. In this case, the FIRST event management software randomly selects some teams to play an extra MATCH. For the purpose of seeding calculations, those teams are designated as SURROGATES for the extra MATCH. If a team plays a MATCH as a SURROGATE, it is indicated on the MATCH schedule with an * after their team number, it is always their third Qualification MATCH, and the outcome of the MATCH has no effect on the team's ranking. YELLOW and RED CARDS assigned to SURROGATES, however, do carry forward to subsequent MATCHES.

If a team is scheduled to play in a back-to-back MATCHES (e.g., Qualification MATCH 40 and 41) they will receive a minimum break per [T206](#) before their next MATCH.

13.6.3 Qualification Ranking

RANKING POINTS (RP) are units credited to a team based on their ALLIANCE'S performance in Qualification MATCHES. These points are awarded to each eligible team at the completion of each Qualification MATCH per Table 10-2.

A team's RANKING SCORE (RS) is the average number of RANKING POINTS earned by a team throughout their Qualification MATCHES (excluding any SURROGATE MATCH).

All teams participating in Qualification MATCHES are ranked by RANKING SCORE. If the number of teams in attendance is 'n', they are ranked '1' through 'n', with '1' being the team with the highest RANKING SCORE and 'n' being the team with the lowest RANKING SCORE. SURROGATE MATCHES are excluded from all calculations. A MATCH in which a team is DISQUALIFIED contributes 0 to all sort criteria.

Teams are ranked in order, using the sorting criteria defined in Table 13-1

Table 13-1: Qualification MATCH ranking criteria

Order Sort	Criteria
1 st	RANKING SCORE (RS)
2 nd	Average ALLIANCE MATCH points, not including MINOR FOULS and MAJOR FOULS (Average MATCH points minus FOULS)
3 rd	Average BASE points
4 th	Average AUTO points
5 th	Random sort by the <i>FIRST</i> event management software

T601 *DISQUALIFICATION applies only to the DISQUALIFIED team in Qualifications. During Qualification MATCHES, a team DISQUALIFICATION has no effect on their ALLIANCE partner.

13.7 Playoff MATCHES

Playoff MATCHES follow the Qualification MATCHES. In the Playoffs, teams play on set ALLIANCES, chosen during ALLIANCE selection, and advance through a double elimination bracket to determine an event winner. Teams do not earn RANKING POINTS; they advance based on winning or losing MATCHES. If a team is DISQUALIFIED during Playoff MATCHES, the DISQUALIFICATION applies to the entire ALLIANCE, and all teams in the ALLIANCE receive 0 MATCH points.

T701 *Send a STUDENT representative. Each team must choose and send a STUDENT team representative to the ARENA at the designated ALLIANCE selection time (typically just after the last scheduled Qualification MATCH) to represent their team.

Violation: Teams who do not send a representative are ineligible for the playoff tournament

If an absent team would have been an ALLIANCE lead, all lower ranked ALLIANCE leads are promoted 1 spot.

If a team is planning to not participate in the playoff tournament, they should proactively inform the Event Director and Head REFEREE as soon as possible.

T702 *Declining teams cannot be picked. An ALLIANCE CAPTAIN may not invite a team that has declined another ALLIANCE'S invitation to participate in the playoff tournament.

Violation: The ALLIANCE CAPTAIN must make another selection

An ALLIANCE lead that declines an invitation from another ALLIANCE is able to invite teams to join their ALLIANCE but may not be invited to join another ALLIANCE.

T703 *There are no backup teams in Playoff MATCHES. An ALLIANCE may not request a backup team in a Playoff MATCH.

Teams are encouraged to consider reliability when selecting partners because all teams on an ALLIANCE must play in each round of the playoff tournament.

T704 *During Playoff MATCHES, teams may have more ARENA access. At the direction of the Event Director, during the Playoff MATCHES teams may need extra team members to maintain the ROBOT between MATCHES in a timely manner. Each team is permitted to have up to 3 additional pit crew members to help with needed ROBOT repairs. These team members should be granted the same ARENA access as the DRIVE TEAM but may not participate in any MATCH play.

This allocation of additional pit crew members is venue specific and at the discretion of the Event Director.

T705 *Multiple DISQUALIFICATION is handled specially. During Playoff MATCHES, 1 or more ALLIANCE DISQUALIFICATIONS are handled accordingly:

- A. if an ALLIANCE is DISQUALIFIED, the DISQUALIFIED ALLIANCE loses
- B. if both ALLIANCES are DISQUALIFIED, the one that is DISQUALIFIED first chronologically loses

- C. if, in the judgement of the Head REFEREE, both ALLIANCES are simultaneously DISQUALIFIED, the MATCH results in a tie

13.7.1 ALLIANCE Selection Process

At the end of the Qualification MATCHES, the top ranked teams become the ALLIANCE leads. The designated STUDENT representative from each ALLIANCE lead is called the ALLIANCE CAPTAIN. This representative may change between ALLIANCE selection and Playoff MATCHES.

The ranked ALLIANCES are designated, in order, ALLIANCE 1, ALLIANCE 2, etc., down to the maximum number of ALLIANCES shown in Table 13-2. Using the ALLIANCE selection process described in this section, each ALLIANCE lead chooses 1 other team to join their ALLIANCE.

If the team accepts, it becomes a member of that ALLIANCE. If an invitation from an ALLIANCE lead to another ALLIANCE lead is accepted, all lower ALLIANCE leads are promoted 1 spot. The highest-ranked, unselected team becomes the newest ALLIANCE lead.

If the number of complete ALLIANCES in Table 13-2 cannot be formed (e.g., due to too many declining teams, due to teams leaving early) the event will proceed by playing with incomplete ALLIANCES. ALLIANCES with 0 teams will grant an automatic win to the opponent and the MATCH will be skipped. ALLIANCES with only 1 team will play the MATCH 1 versus 2.

13.7.2 Playoff MATCH Bracket

The Playoff MATCH bracket is how the event winners are determined.

The number of ALLIANCES for an event is determined by the number of teams who are eligible to participate in the Playoffs based on all Qualification MATCH participating teams as shown in Table 13-2.

Teams that sign up for the event but do not show up, and teams that participate in Awards but are not included in the Qualification MATCHES are not included in determining the Playoff MATCH bracket size. Teams that participated in the Qualification MATCHES but don't intend to participate in the Playoff MATCH bracket are included in determining the Playoff MATCH bracket size.

Table 13-2: Number of playoff ALLIANCES based on all Qualification Match participating teams

Total playoff eligible teams	Number of playoff ALLIANCES formed
4-10 Teams	2
11-20 Teams	4
21-40 Teams	6
41-64 Teams	8

See section [13.8 Dual Division Events](#) for the additional dual division related rules.

The double elimination tournament consists of an upper and lower bracket that will scale based on the number of ALLIANCES. Tournaments with 2 ALLIANCES will have those ALLIANCES face each other in the finals.

Each ALLIANCE begins in the upper bracket. If an ALLIANCE wins a MATCH in the upper bracket, they remain in the upper bracket. If an ALLIANCE loses a MATCH in the upper bracket, they transition to the lower bracket. ALLIANCES in the lower bracket must win all subsequent MATCHES to remain in the tournament, i.e., once they lose 2 total MATCHES, they are out of the tournament.

Ties play another MATCH until the MATCH results in 1 winner.

In Round 1, the higher ranked ALLIANCE is assigned to the red ALLIANCE. For subsequent rounds, ALLIANCE color is assigned as shown in Figure 13-2, regardless of ALLIANCE rank at the start of the playoff tournament.

As shown in Figure 13-2, Playoff MATCHES consist of up to 6 rounds with breaks between later rounds. Breaks begin after the MATCH RESULTS have been posted from the latest MATCH. The Blue and Red Gap columns indicate the approximate time between each ALLIANCE'S MATCHES. The expected start time of the scheduled MATCH is the time indicated on the MATCH schedule or 8 minutes from the end of either ALLIANCE'S previous MATCH, whichever is later per [T206](#).

Figure 13-2: 8-ALLIANCE playoff bracket

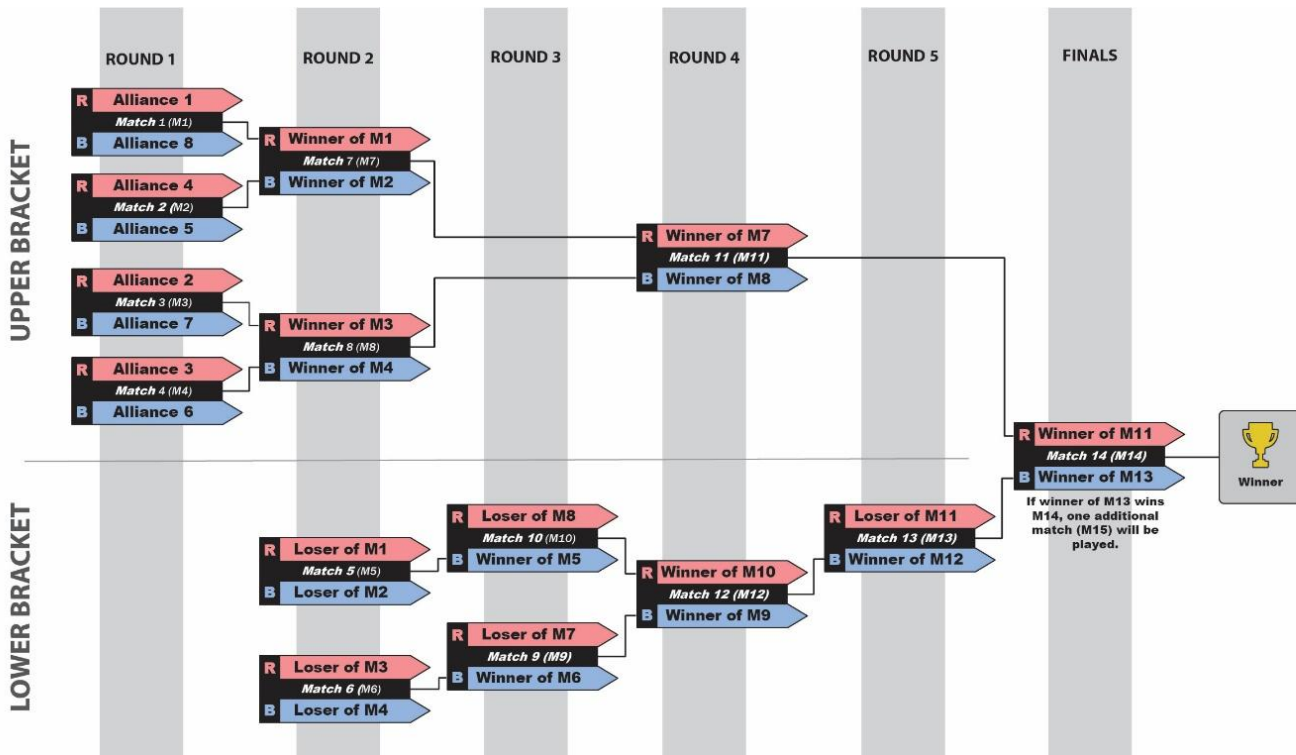

If a Playoff MATCH needs to be replayed as described in section [13.3 MATCH Replays](#) or an additional MATCH needs to be played due to tie, teams are notified of when the MATCH will occur. A minimum 8-minute delay is provided for teams to reset their ROBOTS prior to the MATCH unless all teams are ready sooner ([T206](#)). The affected MATCH must be played before the next round begins.

13.7.3 2-ALLIANCE Bracket and Typical Timing

Figure 13-3: 2-ALLIANCE playoff bracket

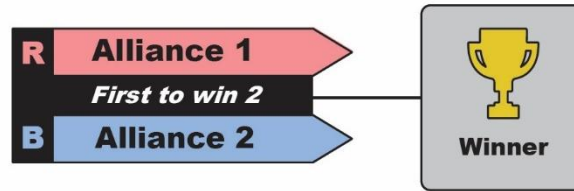

Table 13-3: 2-ALLIANCE playoff bracket typical timing

Round	MATCH	Upper/ Lower	Gap (min)					Next MATCH (MATCH # (ALLIANCE color))		Estimated Start (min)
			FIELD	Blue	Red	Blue	Red	Winner	Loser	
8-minute break			Judges' Choice* (1), Innovate/Design/Control Award (1)							0
Finals	1		1	A2	A1			M2	M2	15
8-minute break			Sustain/Reach/Connect Award (1)							18
Finals	2		1	A2	A1	0:15	0:15	M3*	M3*	33
8-minute break			Think Award (1)							36
Finals	3*		1	A2	A1	0:10	0:10			46
Awards: Compass*, Finalists, Winners, and Inspire Award (1)										49

* if required

**Awards may be given out after the conclusion of the playoff bracket at the discretion of the Event Director.

13.7.4 4-ALLIANCE Bracket and Typical Timing

Figure 13-4: 4-ALLIANCE playoff bracket

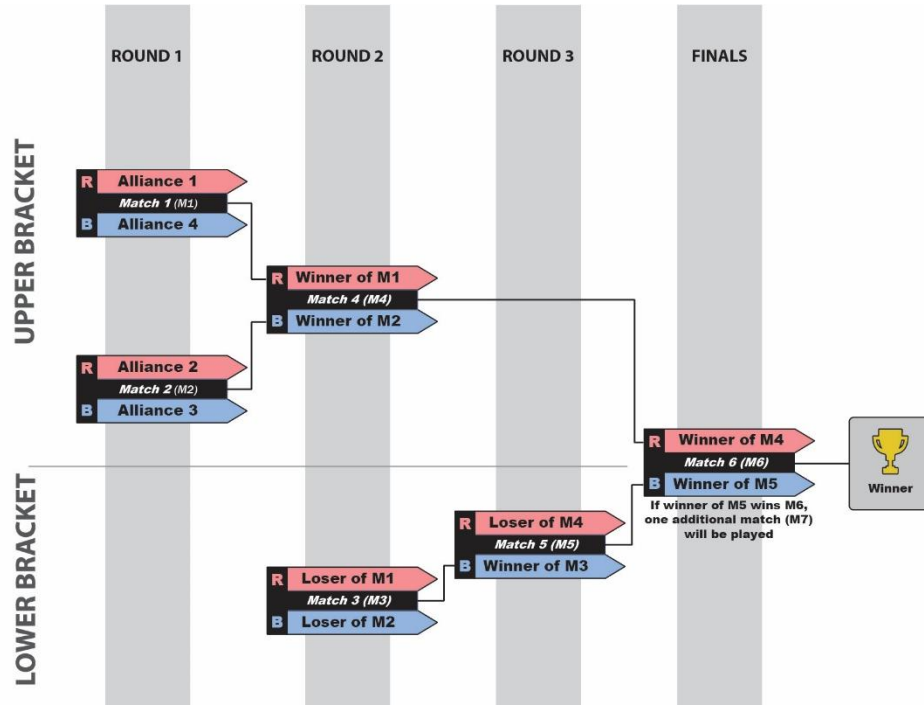

Table 13-4: 4-ALLIANCE playoff typical timing

Round	MATCH	Upper/ Lower	FIELD	Gap (min)				Next MATCH (MATCH # (ALLIANCE color))		Estimated Start (min)
				Blue	Red	Blue	Red	Winner	Loser	
1	1	Upper	1	A4	A1			M4 (R)	M3 (R)	0
	2	Upper	1	A3	A2			M4 (B)	M3 (B)	6
8-minute break									9	
2	3	Lower	1	L2	L1	0:08	0:14	M5 (B)	4th	17
	4	Upper	1	W2	W1	0:14	0:20	M6 (R)	M5 (R)	23
8-minute break			Judges' Choice* (1), Design Award (1), Reach Award (1)						26	
3	5	Lower	1	W3	L4	0:21	0:15	M6 (B)	3rd	34
8-minute break			Control Award (1), Innovate Award (1), Sustain Award (1)						37	
Finals	6		1	W5	W4	0:15	0:33	M7*	M7*	45
8-minute break			Connect Award (1), Think Award (1)						48	
Finals	7*		1	W5	W4	0:15	0:15			56
Awards: Compass*, Finalists, Winners, and Inspire Award (2, 1)									59	

*If Required

**Awards may be given out after the conclusion of the playoff bracket at the discretion of the Event Director.

13.7.5 6-ALLIANCE Bracket and Typical Timing

Figure 13-5: 6-ALLIANCE playoff bracket

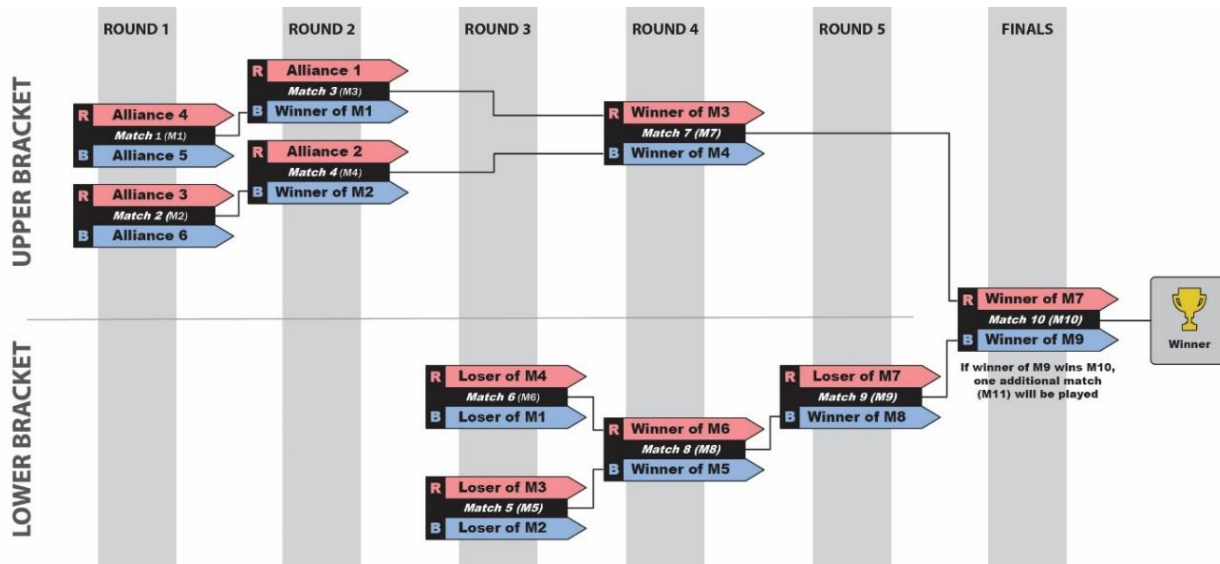

Table 13-5: 6-ALLIANCE playoff bracket typical timing

Round	MATCH	Upper/ Lower	FIELD	Gap (min)				Next MATCH (MATCH # (ALLIANCE color))		Estimated Start (min)
				Blue	Red	Blue	Red	Winner	Loser	
1	1	Upper	1	A5	A4			M3 (B)	M6 (B)	0
	2	Upper	2	A6	A3			M4 (B)	M5 (B)	6
2	3	Upper	1	W1	A1	0:09		M7 (R)	M5 (R)	12
	4	Upper	2	W2	A2	0:09		M7 (B)	M6 (R)	18
3	5	Lower	1	L2	L3	0:15	0:09	M8 (B)	Tied 5th	24
	6	Lower	2	L1	L4	0:27	0:09	M8 (R)		30
4	7	Upper	1	W4	W3	0:15	0:21	M10 (R)	M9 (R)	36
	8	Lower	2	W5	W6	0:15	0:09	M9 (B)	4th	42
8-minute break			Judges' Choice* (1), Design Award (2, 1), Reach Award (2, 1)							45
5	9	Lower	1	W8	L7	0:15	0:21	M10 (B)	3rd	53
8-minute break			Control Award (2, 1), Innovate Award (2, 1), Sustain Award (2,1)							56
Finals	10		1	W9	W7	0:15	0:39	M11*	M11*	64
8-minute break			Connect Award (2, 1), Think Award (2, 1)							67
Finals*	11		1	W9	W7	0:15	0:15			75
Awards: Compass*, Finalists, Winners, and Inspire Award (3, 2, 1)										78

* if required

**Awards may be given out after the conclusion of the playoff bracket at the discretion of the Event Director.

13.7.6 8-ALLIANCE Bracket and Typical Timing

Figure 13-6: 8-ALLIANCE playoff bracket

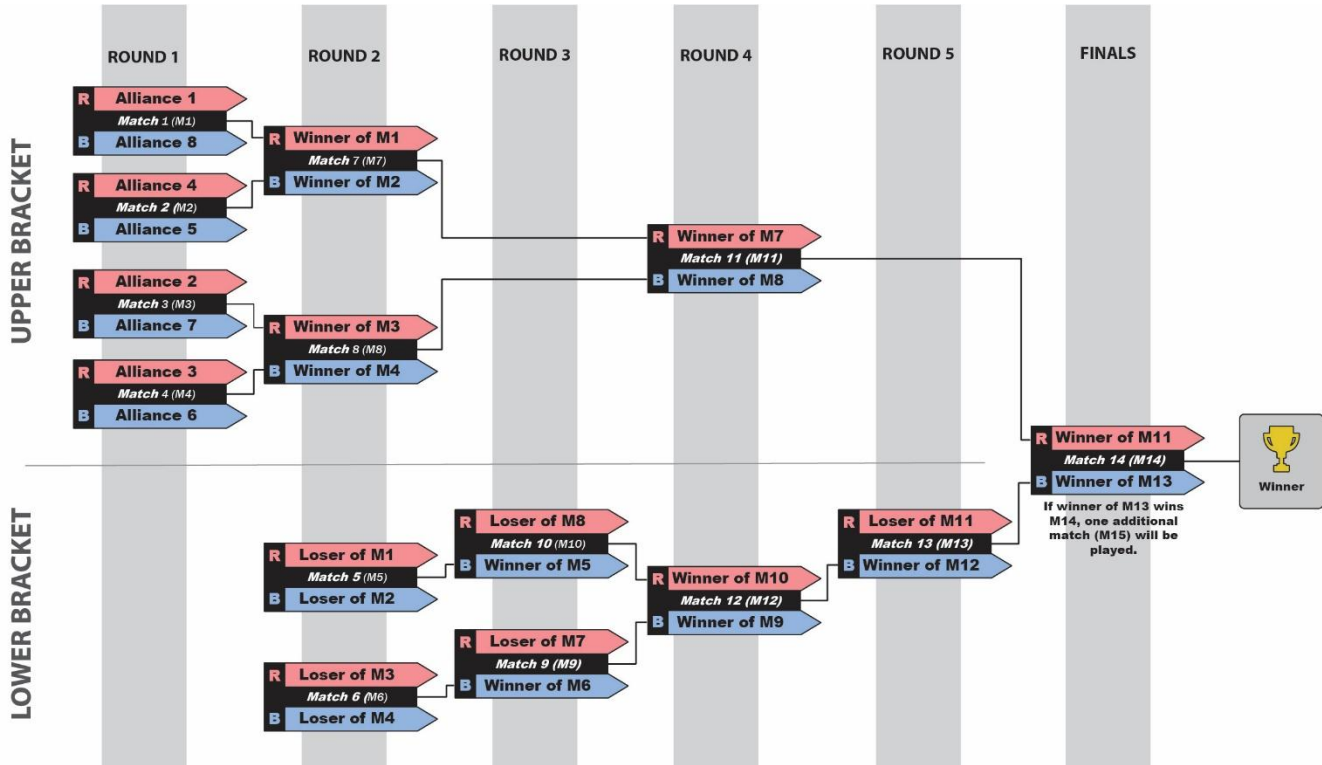

Table 13-6: 8-ALLIANCE playoff bracket typical timing

Round	MATCH	Upper/ Lower	FIELD	Gap (min)				Next MATCH (MATCH # (ALLIANCE color))		Estimated Start (min)
				Blue	Red	Blue	Red	Winner	Loser	
1	1	Upper	1	A8	A1			M7 (R)	M5 (R)	0
	2	Upper	2	A5	A4			M7 (B)	M5 (B)	6
	3	Upper	1	A7	A2			M8 (R)	M6 (R)	12
	4	Upper	2	A6	A3			M8 (B)	M6 (B)	18
2	5	Lower	1	L2	L1	0:15	0:21	M10 (B)	Tied 7th	24
	6	Lower	2	L4	L3	0:09	0:15	M9 (B)		30
	7	Upper	1	W2	W1	0:27	0:33	M11 (R)	M9 (R)	36
	8	Upper	2	W4	W3	0:21	0:27	M11 (B)	M10 (R)	42
3	9	Lower	1	W6	L7	0:15	0:09	M12 (B)	Tied 5th	48
	10	Lower	2	W5	L8	0:27	0:09	M12 (R)		54
4	11	Upper	1	W8	W7	0:15	0:21	M14 (R)	M13 (R)	60
	12	Lower	2	W9	W10	0:15	0:09	M13 (B)	4th	66
8-minute break		Judges' Choice* (1), Design Award (3,2,1), Reach Award (3,2,1)								69
5	13	Lower	1	W12	L11	0:15	0:21	M14 (B)	3rd	77
8-minute break		Control Award (3,2,1), Innovate Award (3,2,1), Sustain Award (3,2,1)								80
Finals	14		1	W13	W11	0:15	0:39	M15*	M15*	88
8-minute break		Connect Award (3,2,1), Think Award (3,2,1)								91
Finals*	15		1	W13	W11	0:15	0:15			99
Awards: Compass*, Finalists, Winners, and Inspire Award (3, 2, 1)										102

* if required

**Awards may be given out after the conclusion of the playoff bracket at the discretion of the Event Director.

13.8 Dual Division Events

Dual Division events are typically larger events which run as 2 different competition events (e.g., 2 parallel Qualifying Tournaments each with a minimum of 2 fields each) with concurrent judging for all teams. After the Playoff MATCHES have concluded in each division, the 2 division winning ALLIANCES compete to determine the overall event winner.

Advancement from a Dual Division event is defined in section [13.8.1 Dual Division Advancement Points](#).

In Dual Division events, teams can be assigned to division in a few different methods briefly described below. For complete details reference the event management software documentation. The method used is at the discretion of the local Program Delivery Partner.

- A. **Random Assignment** – Random division assignment take the team list, shuffles it, and splits the list in half. If equal division sizes cannot be made, the software randomly chooses which division will have an extra team.
- B. **FIM Method** – Algorithm is based on the process developed by *FIRST* in Michigan (FIM) and utilizes a “brute force randomizer” approach. It attempts to balance ROBOT performance while maintaining a decent factor of randomness. Teams are ranked based on a qualification performance metric based on the two best events and then assigned to quartiles and distributed between divisions such that each quartile is equally represented. Division assignments are measured against several metrics to ensure divisions are closely matched.
- C. **Alternating Assignment** – Alternating division assignment sorts the team list by team number, then assigns teams by alternating divisions while iterating through the team list. The lowest team number will be assigned Division 1, the next Division 2, then Division 1, etc.
- D. **Child League Split-up** (only available for League Tournaments) – Algorithm attempts to balance the representation of each child league in each division.
- E. **OPR Method** – Algorithm attempts to balance the ROBOT performance across the division. It calculates every team’s Offensive Power Rating (OPR) for every official event they competed in for the current season and selects each team’s highest OPR. Then it ranks all the teams by highest OPR and alternately assigns teams from highest to lowest OPR into each division.
- F. **Manual** – The Program Delivery Partner can upload a list of manually assigned teams.

In addition to rules listed in previous manual sections, Dual Division event have the following rules:

- T801** *Divisions will use the same size playoff brackets. The number of playoff ALLIANCES will be determined based on the number of playoff eligible teams in the smaller division as shown in Table 13-2.
- T802** *Dual-Division awards are given at the event level. All awards are judged and awarded at the tournament level, not the division level.
- T803** *Dual-Division award counts are based on total teams. The number of awards distributed at a Dual Division event is determined using Table 6-1.

13.8.1 Dual Division Advancement Points

For Dual Division events, advancement points are calculated per Table 4-1 except for playoff advancement points which are instead calculated as described in Table 13-7 below.

Table 13-7: Dual Division Playoff Advancement Points

Category	Advancement Points Earned
Playoff Advancement	40 points for 1 st Place (Winners) 20 points for 2 nd Place (Finalists) 10 points for all Division Finalists 5 points for all Division 3 rd Places

13.8.2 Dual Division Playoffs

Each division plays a standard tournament as described in Section [13.6 Qualification MATCHES](#) followed by Divisional Playoffs to produce the Division Winning ALLIANCE. Those 2 Division Winners have their win-loss records reset and proceed to play each other in a 2-ALLIANCE double eliminations bracket.

Divisions are ranked by the criteria in Table 13-1 excluding RANKING SCORE.

Figure 13-7: 2-ALLIANCE grand finals playoff bracket (Dual Division)

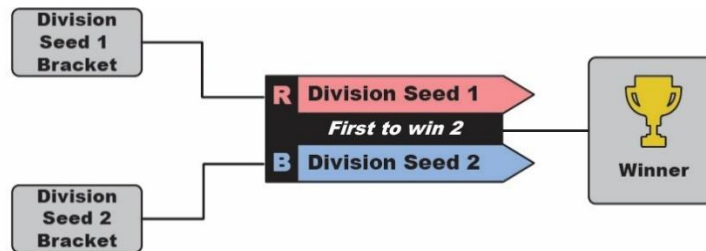

Dual division events will play divisional playoff brackets and then the two ALLIANCES will play as shown in Figure 13-7. The first to win 2 will be the event winner. An example of Dual Division Playoff Timing is shown in Table 13-8.

Table 13-8: 6-ALLIANCE Dual Division playoff bracket typical timing

Round	MATCH	Upper/ Lower	FIELD	Gap (min)				Next MATCH (MATCH # (ALLIANCE color))		Estimated Start (min)
				Blue	Red	Blue	Red	Winner	Loser	
1	1	Upper	1	A5	A4			M3 (B)	M6 (B)	0
	2	Upper	2	A6	A3			M4 (B)	M5 (B)	6
2	3	Upper	1	W1	A1	0:09		M7 (R)	M5 (R)	12
	4	Upper	2	W2	A2	0:09		M7 (B)	M6 (R)	18
3	5	Lower	1	L2	L3	0:15	0:09	M8 (B)	Tied 5th	24
	6	Lower	2	L1	L4	0:27	0:09	M8 (R)		30
4	7	Upper	1	W4	W3	0:15	0:21	M10 (R)	M9 (R)	36
	8	Lower	2	W5	W6	0:15	0:09	M9 (B)	4th	42
8-minute break										45
5	9	Lower	1	W8	L7	0:08	0:14	M10 (B)	3rd	53
8-minute break										56
Finals	10		1	W9	W7	0:08	0:25	M11*	M11*	64
8-minute break										67
Finals*	11		1	W9	W7	0:08	0:08	F1		75
End of Divisional Playoffs/ Judges Choice*(1), Design Award, (3, 2, 1), Reach Award (3, 2, 1)										78
Event Finals 1	F1		1	DivA	DivB	0:15	0:15	F2	F2	86
8-minute break Control Award (3, 2, 1), Innovate Award (3, 2, 1), Sustain Award (3, 2, 1)										89
Event Finals 2	F2		1	DivA	DivB	0:08	0:08	F3*	F3*	97
8-minute break Connect Award (3, 2, 1), Think Award (3, 2, 1)										100
Event Finals 3*	F3*		1	DivA	DivB	0:08	0:08			108
Awards: Compass*, Div. Finalists, Division Winners, Event Finalist, Event Winners and Inspire Award (3, 2, 1)										111

* if required

**Awards may be given out after the conclusion of the playoff bracket at the discretion of the Event Director.

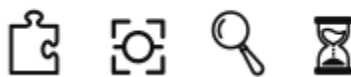

14 League Play Tournaments (L)

Not all regions offer participation in League play. Leagues are closed groups of teams which play in multiple different League Meet events typically spread over several weeks or months. All the teams in the same League should have the opportunity to play in a roughly equal number of MATCHES. A minimum of 10 League Meet MATCHES should be played by all teams in the League.

League Meet events each play between 5 and 6 Qualification MATCHES per team as described in section [13.6 Qualification MATCHES](#) but do not include Playoff MATCHES or judging for awards.

In addition, the behavior described in section [10.6.1 YELLOW and RED CARDS](#), VERBAL WARNINGS, and CARDS also clear at the end of each League Meet event.

Teams may belong to only 1 League per season and can participate in only 1 League Tournament per season. A team can participate in a League outside their region, provided that is the only league they participate in. A team may not advance from a League Tournament to a Regional Championship that is outside of their region unless the Program Delivery Partners in both regions have agreed to move a team to a new region for the entire season.

League Tournaments function the same as a Qualifying Tournament including judging and advancement except that qualification rankings as described in section [13.6 Qualification MATCHES](#), used for both ALLIANCE Selection and Qualification Round Performance Points, are calculated with the addition of each team's top 10 MATCHES played at any League Meet and the matches played at the League Tournament. Top MATCHES are defined by the sort order in Table 13-1.

Teams that played fewer than 10 MATCHES at League Meets will have RANKING POINTS, MATCH Points, and all scoring criteria, that are effectively 0 for the missing MATCHES.

League Tournament advancement (Table 4-1) is calculated only using team performance at the League Tournament except for the Qualification Round Performance which is based on the League Tournament Ranking which include the top 10 League Meet MATCHES as described above.

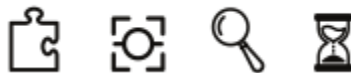

15 FIRST Championship (C)

At the 2025-26 FIRST Championship, teams are split into 6 divisions. Each division plays a standard tournament as described in section [13.6 Qualification MATCHES](#) and section [13.7 Playoff MATCHES](#) to produce the Division Winning ALLIANCES. Those 6 Division Winning ALLIANCES proceed to the Championship Playoffs, on the FIRST Championship FIELD(s), to determine the 2025-26 FIRST Tech Challenge Championship Winners, per [15.5 FIRST Championship](#).

15.1 Awards Modifications

The Judging process will be modified for the FIRST Championship to accommodate for venue limitations and the large number of teams at the event. The process and awards modifications are described below.

Awards from section [6 Awards \(A\)](#) are all awarded in each division only, except for as shown in Table 15-1. All teams attending the FIRST Championship are eligible for any team judged award they meet the criteria for regardless of awards won at prior events.

Table 15-1: FIRST Championship Awards

Award	Per Division	FIRST Championship
Inspire Award	1 st , 2 nd and 3 rd Place	1 st Place*
FIRST Leadership Award	0	10
Compass Award	0	1
*The FIRST Championship Inspire Award Winner will be selected from one of the 6 Division Inspire Award Winners.		

15.1.1 Championship Portfolio Submissions

As outlined in [A201](#) and [A202](#), teams have the opportunity submit a team PORTFOLIO to be used as part of the judging process. For the FIRST Championship, teams will be required to submit their PORTFOLIOS online ahead of the event. PORTFOLIO submission instructions can be found in the [FTC Scoring – Team and Coach Guide](#). PORTFOLIOS can be uploaded between March 27th and April 6th at 11:59 PM CDT. For any issues with PORTFOLIO submissions please email customerservice@firstinspires.org.

15.1.2 Championship Interview Process

At the FIRST Championship, instead of a structured interview, teams will be judged in pit-based interviews. Teams must attend the initial pit interview to be considered for any judged awards at the FIRST Championship.

During the initial pit interview, teams will have up to 10 minutes to talk to the JUDGES. There are no restrictions on the number of people or restrictions on recordings of audio or video, or photos besides restrictions outlined in [E117](#) during the pit-based interviews.

Initial interviews consist of the following:

- A. In addition to submitting their PORTFOLIOS as outlined in [Section 15.1.1](#), teams are encouraged to have an electronic or physical copy of their PORTFOLIO or other supporting materials available to reference during this interview.
- B. Teams have the opportunity to give a prepared 5-minute uninterrupted presentation
- C. Teams will be asked the same baseline questions:
 - a. Did your team have to make any compromises in your ROBOT design?
 - b. How did your team set your goals and strategies for the season?
- D. If time allows, teams may be asked additional questions by the JUDGES on
 - a. Machine, Creativity, and Innovation (MCI) topics
 - b. Team Attributes (TA) topics

Teams should inform the JUDGES at the start of the interview if they have a presentation or want to proceed directly into the Q&A session.

Teams should be conscious of the time allocated for their interview. Although a team may opt to give a presentation, it is not required, and teams will not be given additional questions and answer time to accommodate this presentation. The interview will conclude after approximately 10 minutes with the JUDGES.

After this initial interview is conducted, JUDGES will continue the judging process using information they gather from the PORTFOLIO (if submitted) and additional interviews outlined in section [6.1.3 Pit Interview\(s\)](#).

Teams are encouraged to have one representative present in their pit during active judging windows as noted in the [Event Public Schedule](#) to help coordinate a meeting with the JUDGES.

JUDGES will make every effort to interview teams in their pit, while respecting MATCH and lunch schedules. When necessary, interviews may take place elsewhere in the pit area, such as in the practice FIELD line.

15.1.3 Championship Compass Award Submissions

Videos for Compass Award at the *FIRST* Championship can be submitted by Lead Coach 1 or 2 using the [submission form](#) by April 8th.

15.2 Game Modification

Game modifications for the *FIRST* Championship are outlined below.

15.2.1 FIELDS

All division FIELDS will be placed on risers which are elevated approximately 24 in. (60.95 cm) from the floor. All DRIVE TEAM members and FIELD STAFF will be at floor level. Approximately 50% of the practice FIELDS will also be elevated for teams to use. To see examples of how the elevated FIELD looks, please watch the field tour video from Kickoff.

FIELDS at the *FIRST* Championship will include the following changes which are aesthetic in nature and will not affect the performance of the FIELD or impact ROBOT designs:

- Metal FIELD components (including the RAMP brackets and extrusions) will be black anodized.
- All AprilTags will be printed in a matte material which is more glare resistant.
- The two side faces of the OBELISK will be partially obstructed, and teams should not rely on these “side” AprilTags to determine the randomized MOTIF selected in each MATCH. The face of the OBELISK facing the FIELD will not be obstructed.
- Several of the screw and nut fasteners used to attach metal brackets to the GOAL will be replaced with aluminum pop-rivets.
- There will be decorative signs attached to the outside of the clear panels of the rear FIELD wall, facing the FIELD. These will be white plastic panels with logos and divisional information.

15.2.2 Scoring and Timing

At *FIRST* Championship, the transition between AUTO and TELEOP is 15 seconds, instead of the 8-second transition mentioned in Section 10.1, Section 10.4, Table 9-1, and Section 16 in the definition of MATCH.

15.3 3-ROBOT ALLIANCES

ALLIANCES at the *FIRST* Championship will be made up of 3 ROBOTS. Before each division playoff tournament, ALLIANCES are selected per the process as described in section [13.7.1 ALLIANCE Selection Process](#); however, the process continues with a 2nd round of selection as follows:

Round 2: The same method is used for each ALLIANCE lead’s second choice except the selection order is reversed, with ALLIANCE 8 picking first and ALLIANCE 1 picking last. This process results in 8 ALLIANCES of 3 teams each.

ALLIANCES may start each of their MATCHES with any 2 of the 3 ROBOTS on their ALLIANCE during Division and Championship Playoff MATCHES. ALLIANCES do not need to inform FIELD STAFF of which 2 ROBOTS will play ahead of the MATCH but must not delay the start of the MATCH per [G301](#) by making a late decision.

For example, an ALLIANCE deciding a different set of 2 ROBOTS will be playing in the MATCH after 2 ROBOTS have left queuing is likely a delay of MATCH.

C301 *Replays use the same ROBOTS. If a Playoff MATCH must be replayed, the 2 ROBOTS used in the replay must be the same as in the original MATCH. The sole exception is: if, in the opinion of the Head REFEREE, the ARENA FAULT rendered a ROBOT inoperable, in which case the ROBOTS can be changed. If an additional MATCH is played due to a tie, any 2 of the 3 ROBOTS may be played in the additional MATCH.

FIRST Tech Challenge teams play significantly more matches at the *FIRST* Championship than they do at most events, and there are significantly more teams at the event. Drafting a 3rd ROBOT provides each ALLIANCE with a built-in backup ROBOT and flexibility to draft for different MATCH strategies in mind.

15.4 *FIRST* Championship Pit Crews

Each team on an ALLIANCE playing in the *FIRST* Championship Playoffs may have an additional 3 pit crew team members inside the ARENA to assist with pre-MATCH strategy, ROBOT repair and maintenance, and other team support functions per [T704](#). Additional pit crew members must stay in the pit areas of the ARENA.

The additional team members may be adults or STUDENTS.

15.5 FIRST Championship Playoffs

Each division will play in an 8-ALLIANCE double elimination playoff tournament, as outlined in Section [13.7.6 8-ALLIANCE Bracket and Typical Timing](#). The ALLIANCE that wins their division playoff bracket is the Division Champion.

15.5.1 da Vinci Tournament MATCH Bracket

The 6 Division Champions play a round-robin style tournament. In this format, each Division Champion plays 1 MATCH against each of the other Division Champions. The order of MATCHES is shown in Table 15-2.

Table 15-2 da Vinci playoff schedule

Round	MATCH	Field 1		Field 2		Field 3		Field 4	
		Blue	Red	Blue	Red	Blue	Red	Blue	Red
1	1	Franklin	Edison						
	2			Goodall	Jackson				
	3					Ross	Lovelace		
Break									
2	4							Franklin	Goodall
	5	Jackson	Ross						
	6			Edison	Lovelace				
Break									
3	7					Franklin	Jackson		
	8							Edison	Ross
	9	Goodall	Lovelace						
Break									
4	10			Ross	Franklin				
	11					Edison	Goodall		
	12							Lovelace	Jackson
Break									
5	13	Goodall	Ross						
	14			Jackson	Edison				
	15					Lovelace	Franklin		
Break									
Event Finals 1								RR2	RR1
Break									
Event Finals 2		RR2	RR1						
Break									
Event Finals 3*		RR2	RR1						
*As needed									

15.5.2 da Vinci Round-Robin Tournament Ranking

In the *FIRST* Championship da Vinci round-robin tournament, ALLIANCES do not earn any Ranking Points; they earn Championship Points. Championship Points are units credited to an ALLIANCE based on their performance in each MATCH and are awarded at the completion of each da Vinci round-robin tournament round.

- The winning ALLIANCE receives 2 Championship Points.
- The losing ALLIANCE receives 0 Championship Points.
- In the event of a tied score, each ALLIANCE receives 1 Championship Point.

C501 da Vinci round-robin DISQUALIFICATIONS are handled differently. A team and/or ALLIANCE that is DISQUALIFIED from a da Vinci round-robin MATCH, as determined by the Head REFEREE, causes their ALLIANCE to receive 0 Championship Points and 0 for all other round-robin ranking criteria for the MATCH.

The total number of Championship Points earned by an ALLIANCE throughout the da Vinci round-robin MATCHES divided by the number of da Vinci round-robin MATCHES in which they have been scheduled is their Championship Score (CS).

All ALLIANCES participating in da Vinci round-robin MATCHES are ranked as shown in Table 15-3.

Table 15-3: da Vinci Round-Robin Tournament Ranking Criteria

Order Sort	Criteria
1 st	Championship Score (CS)
2 nd	Average ALLIANCE MATCH points, not including MINOR FOULS and MAJOR FOULS (Average MATCH points minus FOULS)
3 rd	Average BASE points
4 th	Average AUTO points
5 th	Random sort by the <i>FIRST</i> event management software

15.5.3 FIRST Championship da Vinci Finals

The 2 ALLIANCES with the highest rank at the conclusion of the da Vinci round-robin tournament advance to the da Vinci Finals with rank 1 as the red ALLIANCE and rank 2 as the blue ALLIANCE. In the da Vinci Finals, ALLIANCES do not earn Ranking Points or Championship Points.

The first ALLIANCE to win 2 MATCHES in da Vinci Finals is declared the 2026 *FIRST* Tech Challenge Champions.

During the da Vinci Finals, if the MATCH score of each ALLIANCE is equal (i.e., the MATCH resulted in a tie), an additional MATCH will be played.

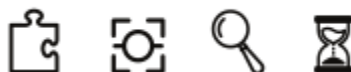

16 Glossary

The following definitions and terms are used for the *FIRST* Tech Challenge game DECODE. Defined terms are in ALL CAPITAL LETTERS throughout the manual (for example, ALLIANCE). Competition rules mean what they plainly say. If a word is not given a game definition, then you should use its common conversational meaning.

Term	Definition
ALLIANCE	a cooperative of 2 <i>FIRST</i> Tech Challenge teams
ALLIANCE AREA	a 96 in. (243.85 cm) wide by 54 in. (137.15 cm) deep by infinitely tall volume formed by placing ALLIANCE colored tape onto the flooring surface outside of the FIELD.
ALLIANCE CAPTAIN	The designated STUDENT representative from each ALLIANCE lead is called the ALLIANCE CAPTAIN.
ARENA	includes all elements of the game infrastructure that are required to play this season's FTC game including: the FIELD, SCORING ELEMENTS, queue area, team media area, and all equipment needed for FIELD control, ROBOT control, and scorekeeping
ARENA FAULT	ARENA FAULT is an error in ARENA operation
ARTIFACT	An ARTIFACT is a 5 in. (12.70 cm) nominal Gopher ResisDent™ polypropylene ball ALLIANCE neutral SCORING ELEMENT.
AUTO	the first 30 seconds of the MATCH, during which DRIVERS may not provide input to their ROBOTS, so ROBOTS operate with only their pre-programmed instructions
BASE	A scoring accomplishment in which ROBOT must be either fully returned or partially returned to their BASE ZONE.
BASE ZONE	an 18 in. +/- 0.125 in. (45.70 cm +/- 0.30 cm) wide by 18 in. +/- 0.125 in. (45.70 cm +/- 0.30 cm) deep infinitely tall volume bounded by ALLIANCE colored tape
CHASSIS	ROBOT'S MAJOR MECHANISM that enables it to move around a FIELD
CLASSIFIED	An ARTIFACT that passes through the SQUARE and transitions directly to the RAMP
CLASSIFIER	a structure attached to the GOAL which has 3 main components: the SQUARE, RAMP, and GATE
COMPONENT	any part in its most basic configuration, which cannot be disassembled without damaging or destroying the part or altering its fundamental function

Term	Definition
CONTINUOUS	describes durations that are more than approximately 10 seconds
CONTROL	<p>an action by a ROBOT in which the SCORING ELEMENT is fully supported by or stuck in, on, or under the ROBOT or it intentionally pushes a SCORING ELEMENT to a desired location or in a preferred direction (i.e., herding). CONTROL requires contact with a ROBOT, either directly or transitively through other SCORING ELEMENTS. Typically, CONTROL requires one of the following to be true:</p> <ul style="list-style-type: none"> A. The SCORING ELEMENT is fully supported by the ROBOT B. The ROBOT is moving the SCORING ELEMENT in a preferred direction with a flat or concave face of the ROBOT
COTS	a standard (i.e., not custom order) part commonly available from a VENDOR for all teams for purchase
CUSTOM CIRCUIT	Any active electrical item that is not an actuator (specified in R501) or power regulation device (specified in R505)
DEPOT	the white tape approximately 30 in. (76.20 cm) long which spans the entire length of the GOAL front face and is located at the base of the GOAL
DISABLED	The REFEREE instructs the team to stop the ROBOT which will deactivate all outputs, rendering the ROBOT inoperable for the remainder of the MATCH
DISQUALIFIED	the state of a team in which they receive 0 MATCH points and 0 RANKING POINTS in a Qualification MATCH or causes their ALLIANCE to receive 0 MATCH points in a Playoff MATCH
DRIVE COACH	a guide or advisor
DRIVE TEAM	a set of up to 4 people from the same FIRST Tech Challenge team responsible for team performance for a specific MATCH
DRIVER	an operator and controller of the ROBOT
DRIVER STATION	Android device (smartphone or REV Driver Hub) that runs the DRIVER STATION App software to communicate with a ROBOT per R901
FABRICATED ITEM	any COMPONENT or MECHANISM that has been altered, built, cast, constructed, concocted, created, cut, heat treated, machined, manufactured, modified, painted, produced, surface coated, or conjured partially or completely into the final form in which it will be used on the ROBOT
FIELD	an approximately 144 in. by 144 in. (365.75 cm by 365.75 cm) area bounded by the inside surface of the walls

Term	Definition
FIELD STAFF	volunteers present in and around the ARENA that are responsible for making sure the MATCHES are cycled through efficiently, fairly, safely, and with a spirit of cooperation, <i>Gracious Professionalism</i> ®, and generosity of spirit
FTA	<i>FIRST</i> Technical Advisor
GATE	an ALLIANCE specific FIELD element that prevents CLASSIFIED ARTIFACTS from exiting the RAMP
GATE ZONE	a 2.75 in. (7.00 cm) wide by 10 in. (25.40 cm) long infinitely tall volume bounded by 2 parallel 10 in. (25.40 cm) long ALLIANCE colored tape segments adjacent to each GATE
GOAL	a 3-sided structure with a horizontal triangular shaped opening at the top
HUMAN PLAYER	a SCORING ELEMENT manager
INSPECTOR	a person determined by <i>FIRST</i> to accurately and efficiently assess the legality of a given part or the whole of a ROBOT, an event volunteer role
JUDGE	JUDGES meet with teams to learn about and celebrate the unique journey and accomplishments of each team and evaluate these against award requirements. JUDGES interact with STUDENTS during the interview process, and in the pits. As a group, JUDGES determine the teams that receive awards at events
LAUNCH/LAUNCHING	An action by a ROBOT in which the SCORING ELEMENT is shot into the air, propelled across the floor to a desired location or in a preferred direction, or thrown in a forceful way
LAUNCH LINE	the white tape which bounds 2 triangular LAUNCH ZONES, as well as 2 segments of white tape located at the base of the GOAL
LAUNCH ZONE	infinitely tall triangular volumes bounded by LAUNCH LINES and the FIELD perimeter
LEAVE	a scoring accomplishment in which a ROBOT must move such that it is no longer over any LAUNCH LINE at the end of AUTO
LOADING ZONE	an approximately 23 in. (58.40 cm) wide by 23 in. (58.40 cm) deep infinitely tall volume bounded by white tape and the adjoining FIELD perimeters
LRI	the Lead ROBOT INSPECTOR
MAJOR FOUL	a credit of 15 points towards the opponent's MATCH point total
MAJOR MECHANISM	a group of COMPONENTS and/or MECHANISMS assembled together to address at least 1 game challenge: ROBOT movement, SCORING ELEMENT

Term	Definition
	manipulation, FIELD element manipulation, or performance of a scorable task without the assistance of another ROBOT.
MATCH	a 30-second AUTO period, an 8-second transition period between AUTO and TELEOP, and a 2-minute TELEOP period in which the ROBOT plays the current season game
MECHANISM	an assembly of COMPONENTS that provide specific functionality on the ROBOT. A MECHANISM can be disassembled (and then reassembled) into individual COMPONENTS without damage to the parts.
MINOR FOUL	a credit of 5 points towards the opponent's MATCH point total
MOMENTARY	describes durations that are fewer than approximately 3 seconds
MOTIF	a series of ARTIFACT colors, comprised of 2 purple (P) and 1 green (G), in a unique order
OBELISK	OBELISK is an equilateral triangular prism located just outside of the FIELD perimeter
OPERATOR CONSOLE	the set of COMPONENTS and MECHANISMS used by the DRIVE TEAM to relay commands to the ROBOT
OVERFLOW	An ARTIFACT that passes through the SQUARE but does not meet CLASSIFIED criteria
PATTERN	A scoring achievement in which points are scored based on the color of the ARTIFACT on the RAMP matching the individual index color defined by the MOTIF
PIN/PINNING	an action by a ROBOT that is preventing the movement of an opponent ROBOT by contact, either direct or transitive (such as against a FIELD element)
PORTFOLIO	A document used as part of the judging process with requirements outlined in A201
RAMP	A structure that can fit up to 9 CLASSIFIED ARTIFACTS
RANKING POINTS (RP)	credited to a team based on their ALLIANCE'S performance in Qualification MATCHES
RANKING SCORE (RS)	A team's RANKING SCORE (RS) is the average number of RANKING POINTS earned by a team throughout their Qualification MATCHES
RED CARD	a penalty issued by the Head REFEREE for egregious ROBOT or team member behavior or rule violations which results in a team being DISQUALIFIED for the MATCH.

Term	Definition
REFEREE	an official who is certified by <i>FIRST</i> to enforce the rules of the current season's game, an event volunteer role
REPEATED	describes actions that happen more than once within a MATCH
ROBOT	an electromechanical assembly built by a <i>FIRST</i> Tech Challenge team to play the current season's game and includes all the basic systems required to be an active participant in the game –power, communications, control, and movement about the FIELD
ROBOT CONTROLLER	Android device (smartphone or REV Control Hub) that runs the ROBOT CONTROLLER app to control the ROBOT as defined in R701
ROBOT SIGN	A ROBOT SIGN simultaneously identifies a ROBOT'S team number as well as its ALLIANCE affiliation for FIELD STAFF.
SCORING ELEMENT	There is 1 type of SCORING ELEMENT used in DECODE: the ARTIFACT.
SECRET TUNNEL ZONE	an approximately 46.5 in. (118.10 cm) long by approximately 6.125 in. (15.55 cm) wide infinitely tall volume bounded by ALLIANCE colored tape, the GOAL assembly, the LOADING ZONE, and the adjoining FIELD perimeter
SIGNAL LEVEL	a term used to characterize circuits which draw $\leq 1A$ continuous and have a source incapable of delivering $>1A$, including but not limited including but not limited to REV Control and Expansion Hub sensor input/output signals (DIO, analog, I2C, encoder, 485)
SPIKE MARK	1 of 6 white tape marks 10 in. (25.40 cm) long used to identify the placement of 3 ARTIFACTS before the MATCH
SQUARE	a location at the top of the RAMP at which ARTIFACT scoring is assessed
STARTING CONFIGURATION	the physical configuration in which a ROBOT starts a MATCH
STUDENT	a person who has not completed high-school, secondary school, or the comparable level in their home region as of September 1 st
SURROGATE	a team randomly assigned by event management software to play an extra Qualification MATCH
TELEOP	second period of each MATCH is 2 minutes (2:00) long and called the teleoperated period (TELEOP). During TELEOP, DRIVERS remotely operate ROBOTS
TILE	flooring surface of the FIELD is made of 36 interlocking soft foam TILES
VENDOR	a legitimate business source for COTS items that satisfies criteria defined in section 12 ROBOT Construction Rules (R)

Term	Definition
VERBAL WARNING	a warning issued by event staff or the Head REFEREE
YELLOW CARD	a warning issued by the Head REFEREE for egregious ROBOT or team member behavior or rule violations
WTA	wireless technical advisor an event volunteer role